

## Z Power LED – Z5-M3

S1W0-3535xxxx03-00000000-00002



## Product Brief

### Description

- The Z-Power series is designed for high flux output applications with high current operation capability.
- It incorporates state of the art SMD design and low thermal resistant material.
- The Z Power LED is ideal light sources for directional lighting applications such as Spot Lights, various outdoor applications, automotive lightings and high performance torches .

### Features and Benefits

- High Lumen Output and Efficacy
- Designed for high current operation
- Low Thermal Resistance
- ANSI compliant Binning
- RoHS compliant
- Ceramic package

### Key Applications

- Architectural
- Industrial
- Outdoor area
- Exterior Lighting
- Commercial

Reference Code	Color	Nominal CCT	Part Number	CRI
				Min
SZ5-M3-W0-00	Cool White	6500K	S1W0-3535657003-00000000-00002	70
		5700K	S1W0-3535577003-00000000-00002	
		5000K	S1W0-3535507003-00000000-00002	
SZ5-M3-WN-00	Neutral White	4000K	S1W0-3535407003-00000000-00002	
		3500K	S1W0-3535357003-00000000-00002	
		3000K	S1W0-3535307003-00000000-00002	
SZ5-M3-WW-00	Warm White	2700K	S1W0-3535277003-00000000-00002	

Reference Code	Color	Nominal CCT	Part Number	CRI
				Min
SZ5-M3-W0-C8	Cool White	6500K	S1W0-3535658003-00000000-00002	80
		5700K	S1W0-3535578003-00000000-00002	
		5000K	S1W0-3535508003-00000000-00002	
SZ5-M3-WN-C8	Neutral White	4000K	S1W0-3535408003-00000000-00002	
		3500K	S1W0-3535358003-00000000-00002	
		3000K	S1W0-3535308003-00000000-00002	
SZ5-M3-WW-C8	Warm White	2700K	S1W0-3535278003-00000000-00002	
		2200k	S1W0-3535228003-00000000-00002	

# Table of Contents

<b>Index</b>	
• Product Brief	1
• Table of Contents	2
• Performance Characteristics	3
• Characteristics Graph	5
• Color Bin Structure	10
• Mechanical Dimensions	15
• Recommended Solder Pad	16
• Reflow Soldering Characteristics	17
• Packaging Information	18
• Product Nomenclature	20
• Handling of Silicone Resin for LEDs	21
• Precaution For Use	22
• Company Information	25

---

## Performance Characteristics

**Table 1. Characteristics**

Parameter	Symbol	Value			Unit
		Min.	Typ.	Max.	
Forward Current <sup>[1]</sup>	$I_F$	-	700	1500	mA
Peak Pulsed Forward Current <sup>[2]</sup>	$I_F$			2000	mA
Forward Voltage (@700mA, 85°C)	$V_F$	-	-	2.95	V
Junction Temperature	$T_j$	-	-	150	°C
Viewing angle	$\theta$		125		degree
Thermal resistance (J to S) <sup>[3]</sup>	$R\theta_{J-S}$	-	3.2	-	K/W
ESD Sensitivity(HBM)		Class 2 JEDEC JS-001-2017			

**Notes :**

- (1) At Junction Temperature 85°C condition.
- (2) Pulse width  $\leq 10\text{ms}$ , duty cycle  $\leq 10\%$  condition.
- (3)  $R\theta_{J-S}$  is tested at 700mA.

- Thermal resistance can be increased substantially depending on the heat sink design/operating condition, and the maximum possible driving current will decrease accordingly.

## Color Bin Structure

**Table 2. Bin Code description,  $I_F=700\text{mA}$ ,  $T_J=85^\circ\text{C}$** 

Luminous Flux [lm]			Typical Forward Voltage [ $V_F$ ]		
Bin Code	Min.	Max.	Bin Code	Min.	Max.
V1	185	203	G	2.75	2.95
V2	203	218			
V3	218	240			
W1	240	256			
W2	256	272			
W3	272	285			
W4	285	299			
W5	299	313			
W6	313	327			

**Notes :** (1) Correlated Color Temperature is derived from the CIE 1931 Chromaticity diagram.

Color coordinate :  $\pm 0.005$ , CCT  $\pm 5\%$  tolerance.

(2) Seoul Semiconductor maintains a tolerance of  $\pm 7\%$  on flux and power measurements.

(3)  $\Phi_v$  is the total luminous flux output as measured with an integrating sphere.

(4) Tolerance is  $\pm 2.0$  on CRI measurements.

(5) Tolerance is  $\pm 0.06\text{V}$  on forward voltage measurements.

## Characteristics Graph

Fig 1. Color Spectrum

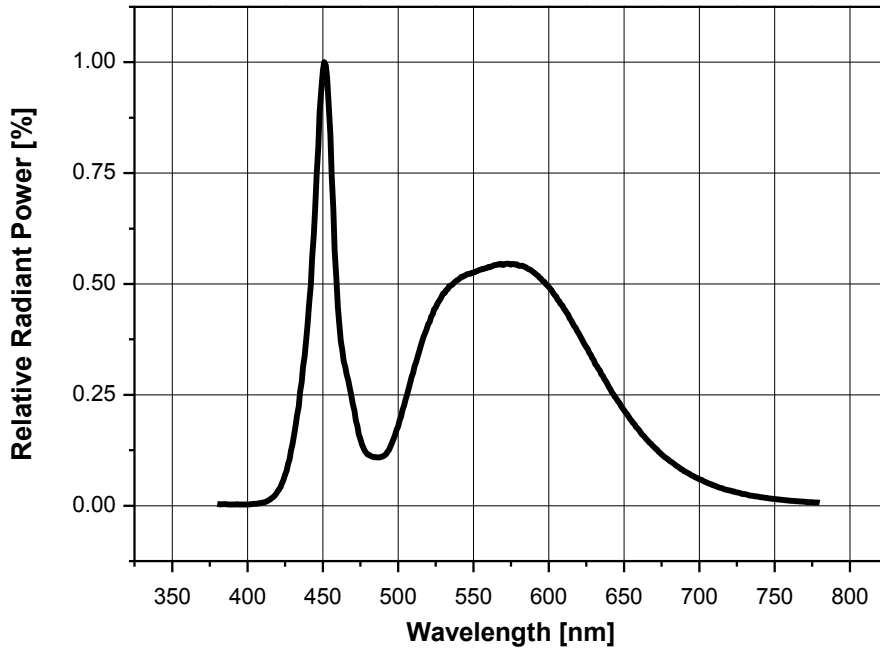
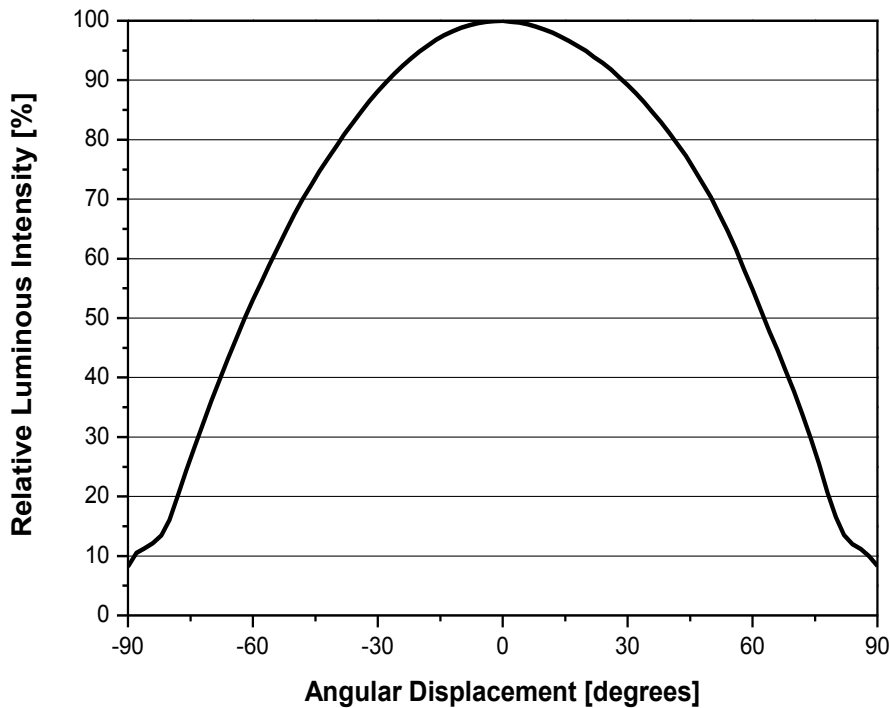
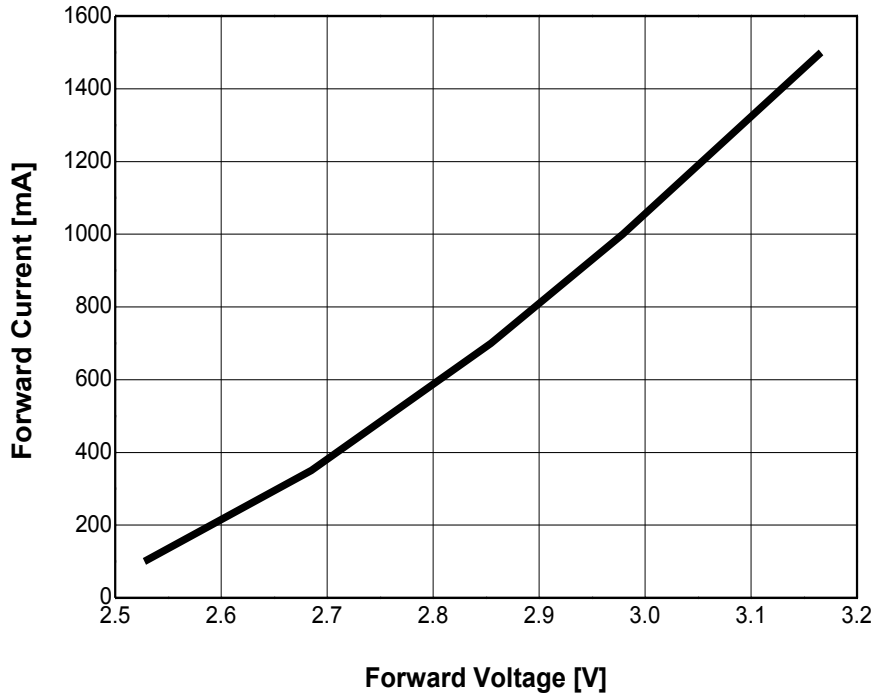

Fig 2. Typical Spatial Distribution



## Characteristics Graph

**Fig 3. Forward Voltage vs. Forward Current,  $T_j=85^\circ\text{C}$**



**Fig 4. Forward Current vs. Relative Luminous Flux,  $T_j=85^\circ\text{C}$**

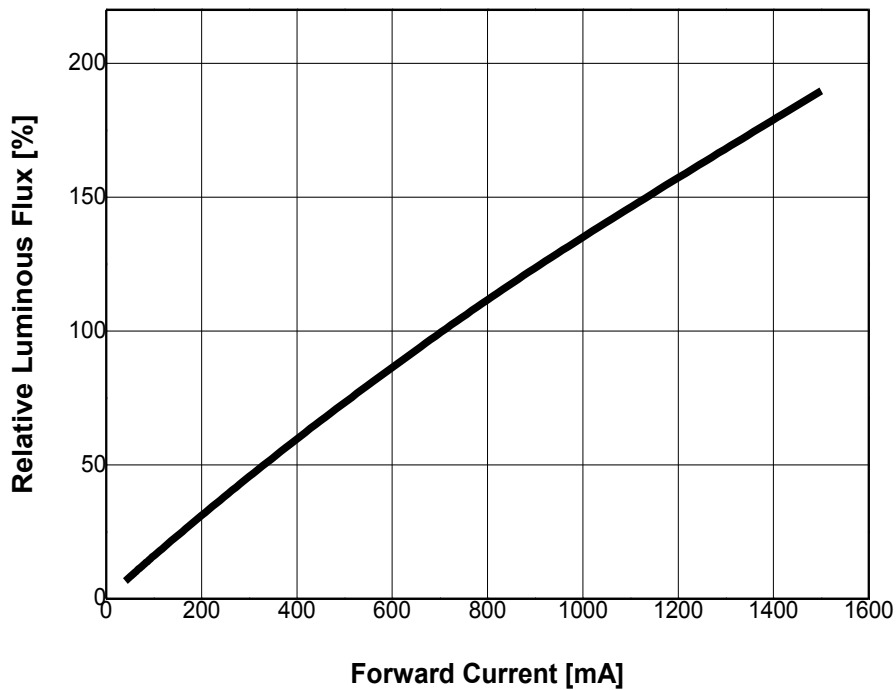

## Characteristics Graph

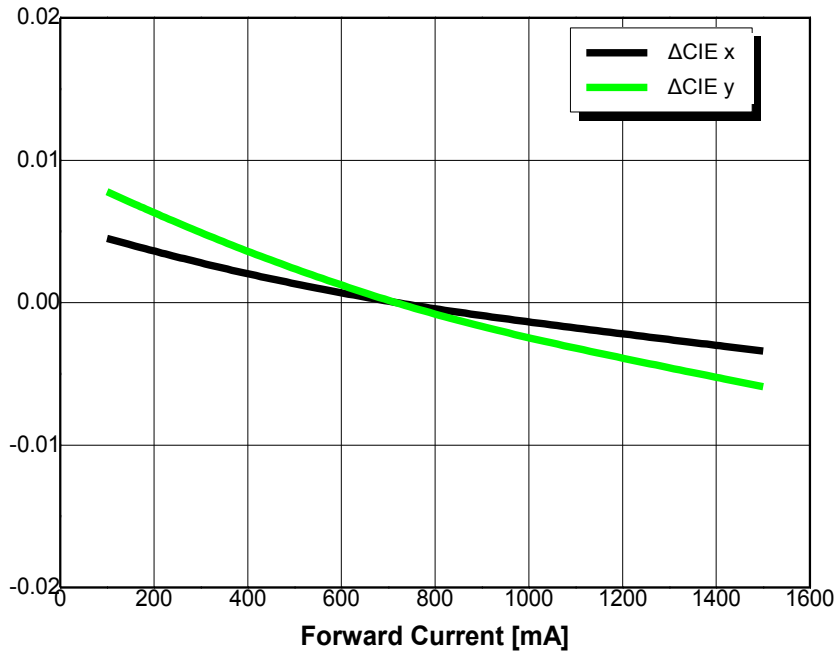
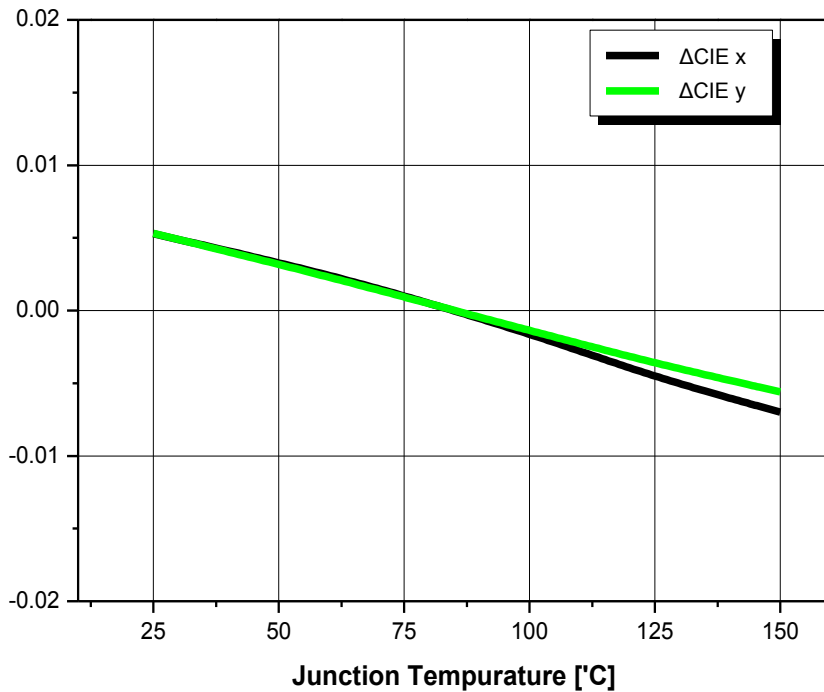
**Fig.5 Forward Current vs CIE x, y Shift**

**Fig.6 Junction Temp. vs. CIE x, y Shift**

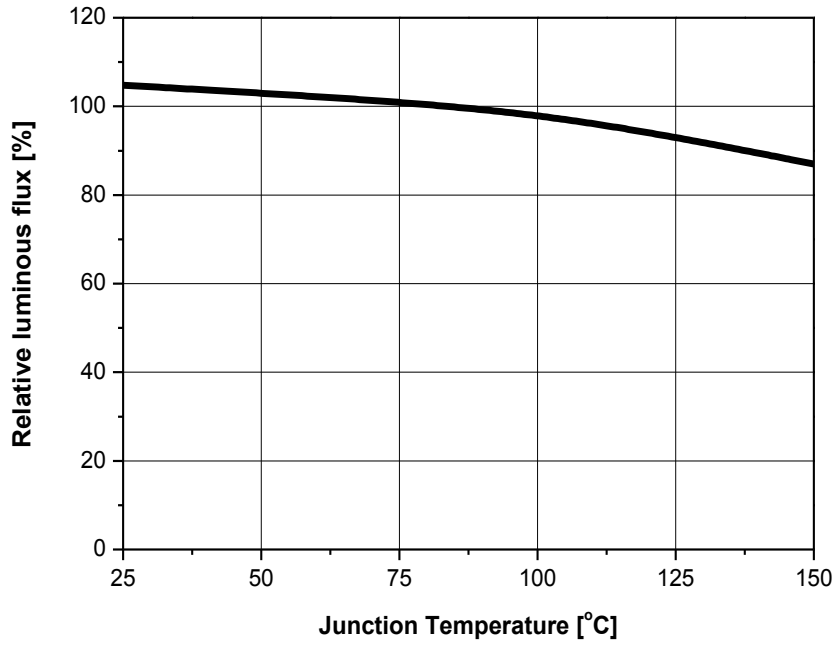
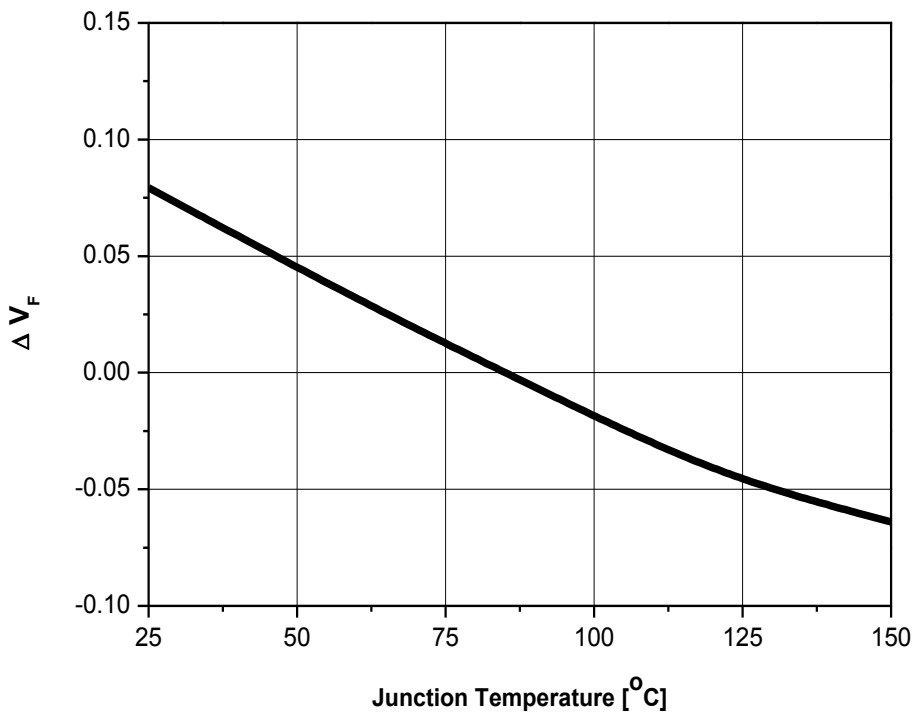
## Characteristics Graph

**Fig 7. Junction Temperature vs. Relative Light Output,  $I_F = 700\text{mA}$** 

**Fig 8. Junction Temperature vs. Relative Forward,  $I_F = 700\text{mA}$** 

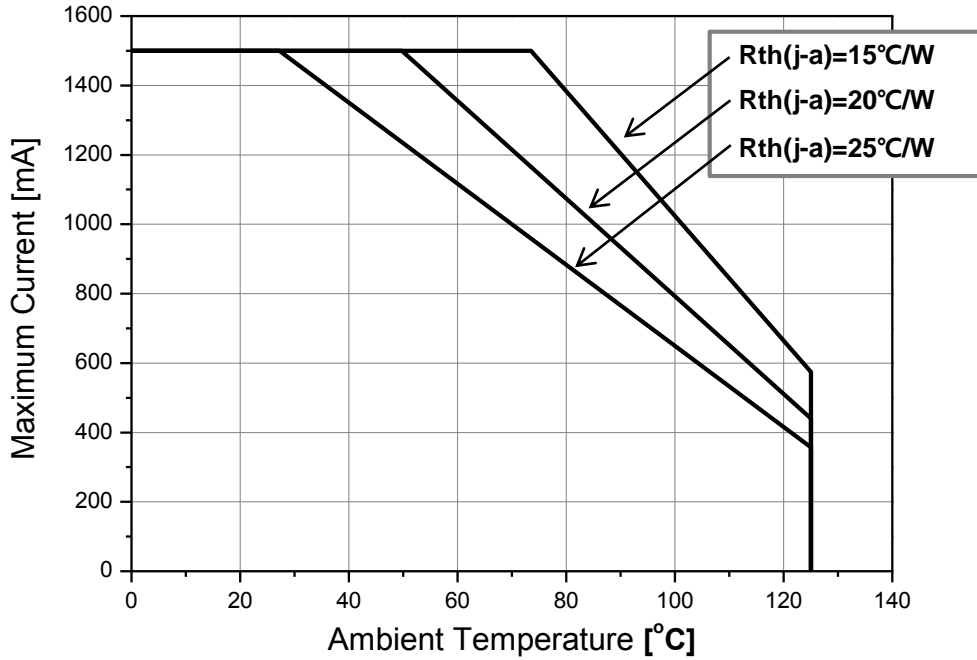

## Characteristics Graph

**Fig 9. Ambient Temperature vs. Maximum Forward Current,  $T_j(\text{max.})=150^\circ\text{C}$ ,  $I_F=1500\text{mA}$**



## Color Bin Structure

**Table 3. Flux Rank Distribution**
**CRI70**
 **Available Rank**

CCT	CIE	Flux Rank						
6000 ~ 7000K	A	V3	W1	W2	W3	W4	W5	W6
5300 ~ 6000K	B	V3	W1	W2	W3	W4	W5	W6
4700 ~ 5300K	C	V3	W1	W2	W3	W4	W5	W6
3700 ~ 4200K	E	V3	W1	W2	W3	W4	W5	W6
3200 ~ 3700K	F	V3	W1	W2	W3	W4	W5	W6
2900 ~ 3200K	G	V3	W1	W2	W3	W4	W5	W6
2600 ~ 2900K	H	V3	W1	W2	W3	W4	W5	W6

**CRI80**
 **Available Rank**

CCT	CIE	Flux Rank						
6000 ~ 7000K	A	V3	W1	W2	W3	W4	W5	W6
5300 ~ 6000K	B	V3	W1	W2	W3	W4	W5	W6
4700 ~ 5300K	C	V3	W1	W2	W3	W4	W5	W6
3700 ~ 4200K	E	V3	W1	W2	W3	W4	W5	W6
3200 ~ 3700K	F	V3	W1	W2	W3	W4	W5	W6
2900 ~ 3200K	G	V3	W1	W2	W3	W4	W5	W6
2600 ~ 2900K	H	V3	W1	W2	W3	W4	W5	W6
2100 ~ 2300K	K	V1	V2	V3	W3	W4	W5	W6

## Color Bin Structure

CIE Chromaticity Diagram (Cool white),  $T_j=85^\circ\text{C}$ ,  $I_f=700\text{mA}$

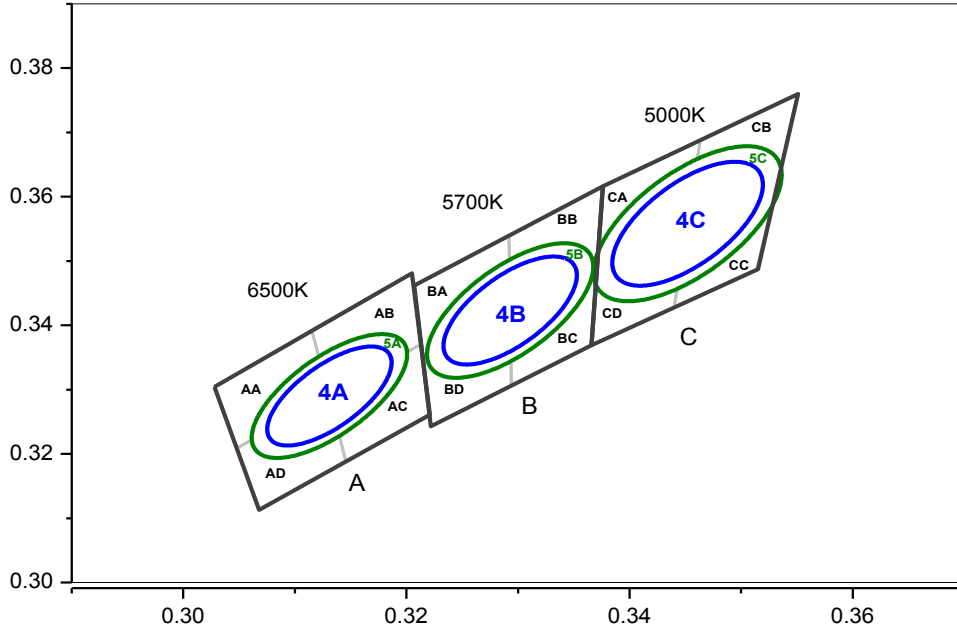

6500K 4Step				5700K 4Step				5000K 4Step			
4A				4B				4C			
Center point		0.3123 : 0.3282		Center point		0.3287 : 0.3417		Center point		0.3447 : 0.3553	
Major Axis a		0.0088		Major Axis a		0.0095		Major Axis a		0.0108	
Minor Axis b		0.0036		Minor Axis b		0.0040		Minor Axis b		0.0047	
Ellipse Rotation Angle		58		Ellipse Rotation Angle		59		Ellipse Rotation Angle		60	
6500K 5Step				5700K 5Step				5000K 5Step			
5A				5B				5C			
Center point		0.3123 : 0.3282		Center point		0.3287 : 0.3417		Center point		0.3447 : 0.3553	
Major Axis a		0.0110		Major Axis a		0.0118		Major Axis a		0.0135	
Minor Axis b		0.0045		Minor Axis b		0.0050		Minor Axis b		0.0058	
Ellipse Rotation Angle		58		Ellipse Rotation Angle		59		Ellipse Rotation Angle		60	
AA		AB		AC		AD					
CIE X	CIE Y	CIE X	CIE Y	CIE X	CIE Y	CIE X	CIE Y				
0.3028	0.3304	0.3115	0.3393	0.3131	0.329	0.3048	0.3209				
0.3048	0.3209	0.3131	0.329	0.3146	0.3187	0.3068	0.3113				
0.3131	0.329	0.3213	0.3371	0.3221	0.3261	0.3146	0.3187				
0.3115	0.3393	0.3205	0.3481	0.3213	0.3371	0.3131	0.329				
BA		BB		BC		BD					
CIE X	CIE Y	CIE X	CIE Y	CIE X	CIE Y	CIE X	CIE Y				
0.3207	0.3462	0.3292	0.3539	0.3293	0.3423	0.3215	0.3353				
0.3215	0.3353	0.3293	0.3423	0.3294	0.3306	0.3222	0.3243				
0.3293	0.3423	0.3371	0.3493	0.3366	0.3369	0.3294	0.3306				
0.3292	0.3539	0.3376	0.3616	0.3371	0.3493	0.3293	0.3423				
CA		CB		CC		CD					
CIE X	CIE Y	CIE X	CIE Y	CIE X	CIE Y	CIE X	CIE Y				
0.3376	0.3616	0.3463	0.3687	0.3452	0.3558	0.3371	0.3493				
0.3371	0.3493	0.3452	0.3558	0.344	0.3428	0.3366	0.3369				
0.3452	0.3558	0.3533	0.3624	0.3514	0.3487	0.344	0.3428				
0.3463	0.3687	0.3551	0.376	0.3533	0.3624	0.3452	0.3558				

## Color Bin Structure

CIE Chromaticity Diagram (Neutral White),  $T_j=85^\circ\text{C}$ ,  $I_f=700\text{mA}$

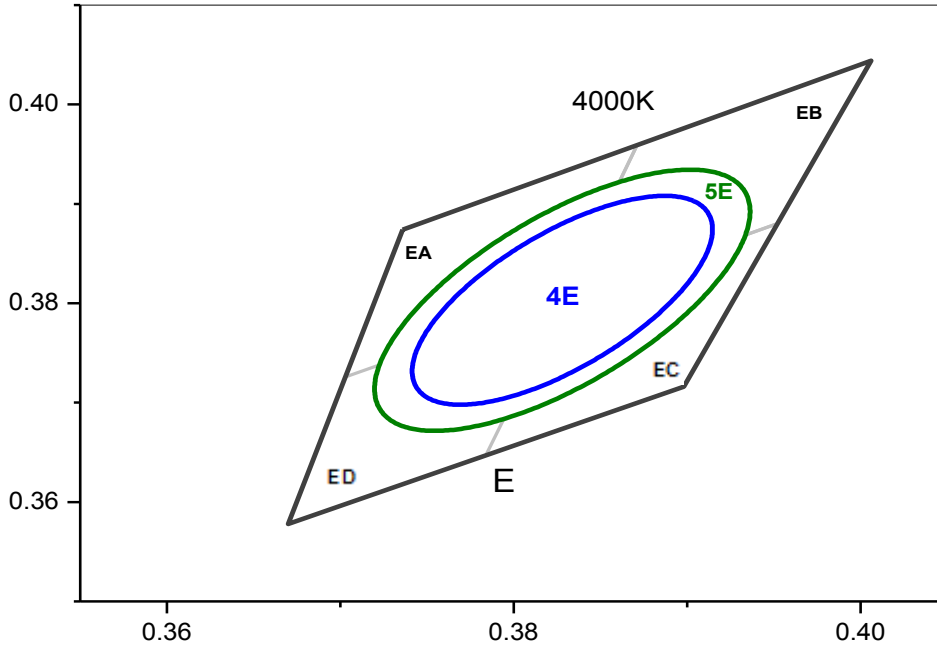

### 4000K 4Step

4E	
Center point	0.3818 : 0.3797
Major Axis a	0.0125
Minor Axis b	0.0053
Ellipse Rotation Angle	53

### 4000K 5Step

5E	
Center point	0.3818 : 0.3797
Major Axis a	0.0157
Minor Axis b	0.0067
Ellipse Rotation Angle	53

EA		EB		EC		ED	
CIE X	CIE Y	CIE X	CIE Y	CIE X	CIE Y	CIE X	CIE Y
0.3736	0.3874	0.3871	0.3959	0.3828	0.3803	0.3703	0.3726
0.3703	0.3726	0.3828	0.3803	0.3784	0.3647	0.367	0.3578
0.3828	0.3803	0.3952	0.388	0.3898	0.3716	0.3784	0.3647
0.3871	0.3959	0.4006	0.4044	0.3952	0.388	0.3828	0.3803

## Color Bin Structure

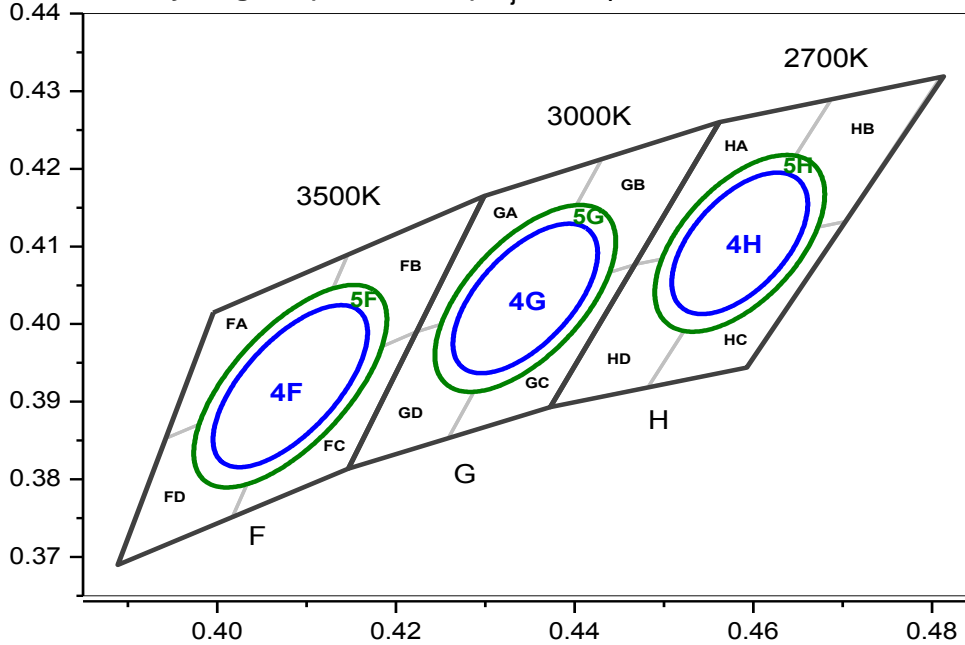
**CIE Chromaticity Diagram (Warm White),  $T_j=85^\circ\text{C}$ ,  $I_f=700\text{mA}$** 

3500K 4Step		3000K 4Step		2700K 4Step			
4F		4G		4H			
Center point	0.4073 : 0.3917	Center point	0.4338 : 0.4030	Center point	0.4578 : 0.4101		
Major Axis a	0.0124	Major Axis a	0.0113	Major Axis a	0.0105		
Minor Axis b	0.0055	Minor Axis b	0.0055	Minor Axis b	0.0055		
Ellipse Rotation Angle	53	Ellipse Rotation Angle	53	Ellipse Rotation Angle	54		
3500K 5Step		3000K 5Step		2700K 5Step			
5F		5G		5H			
Center point	0.4073 : 0.3917	Center point	0.4338 : 0.4030	Center point	0.4578 : 0.4101		
Major Axis a	0.0155	Major Axis a	0.0142	Major Axis a	0.0132		
Minor Axis b	0.0068	Minor Axis b	0.0068	Minor Axis b	0.0068		
Ellipse Rotation Angle	53	Ellipse Rotation Angle	53	Ellipse Rotation Angle	54		
FA		FB		FC		FD	
CIE X	CIE Y	CIE X	CIE Y	CIE X	CIE Y	CIE X	CIE Y
0.3996	0.4015	0.4146	0.4089	0.4082	0.392	0.3943	0.3853
0.3943	0.3853	0.4082	0.392	0.4017	0.3751	0.3889	0.369
0.4082	0.392	0.4223	0.399	0.4147	0.3814	0.4017	0.3751
0.4146	0.4089	0.4299	0.4165	0.4223	0.399	0.4082	0.392
GA		GB		GC		GD	
CIE X	CIE Y	CIE X	CIE Y	CIE X	CIE Y	CIE X	CIE Y
0.4299	0.4165	0.443	0.4212	0.4345	0.4033	0.4223	0.399
0.4223	0.399	0.4345	0.4033	0.4259	0.3853	0.4147	0.3814
0.4345	0.4033	0.4468	0.4077	0.4373	0.3893	0.4259	0.3853
0.443	0.4212	0.4562	0.426	0.4468	0.4077	0.4345	0.4033
HA		HB		HC		HD	
CIE X	CIE Y	CIE X	CIE Y	CIE X	CIE Y	CIE X	CIE Y
0.4562	0.426	0.4687	0.4289	0.4585	0.4104	0.4468	0.4077
0.4468	0.4077	0.4585	0.4104	0.4483	0.3919	0.4373	0.3893
0.4585	0.4104	0.4703	0.4132	0.4593	0.3944	0.4483	0.3919
0.4687	0.4289	0.481	0.4319	0.4703	0.4132	0.4585	0.4104

## Color Bin Structure

CIE Chromaticity Diagram (Warm White),  $T_j=85^\circ\text{C}$ ,  $I_f=700\text{mA}$

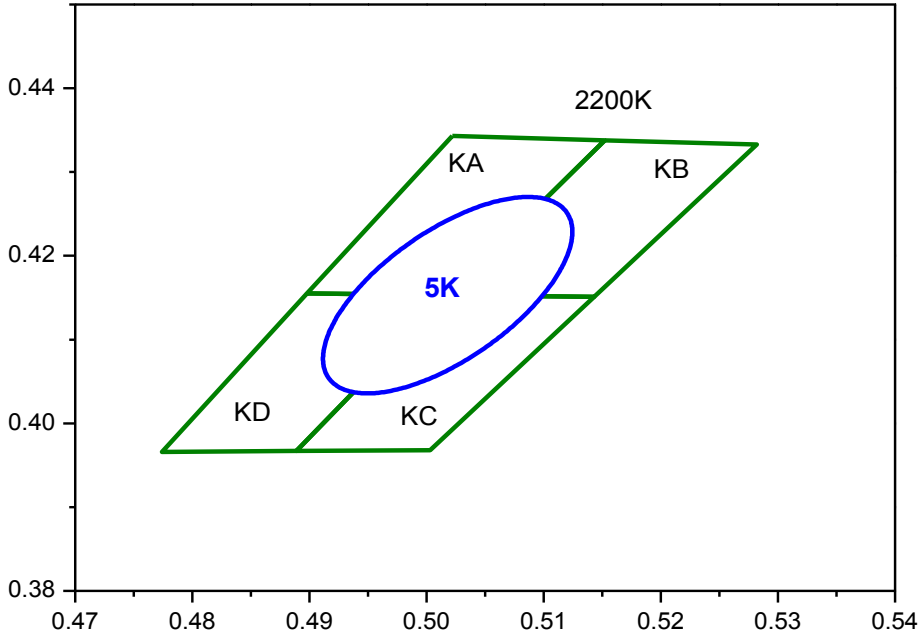

**2200K 5Step**

5K	
Center point	0.5018 : 0.4153
Major Axis a	0.01438
Minor Axis b	0.00663
Ellipse Rotation Angle	49

KA		KB		KC		KD	
CIE x	CIE y	CIE x	CIE y	CIE x	CIE y	CIE x	CIE y
0.5022	0.4343	0.5152	0.4338	0.5018	0.4153	0.4898	0.4155
0.4898	0.4155	0.5018	0.4153	0.4889	0.3967	0.4774	0.3966
0.5018	0.4153	0.5143	0.4151	0.5003	0.3968	0.4889	0.3967
0.5152	0.4338	0.5282	0.4333	0.5143	0.4151	0.5018	0.4153

## Mechanical Dimensions

Top View

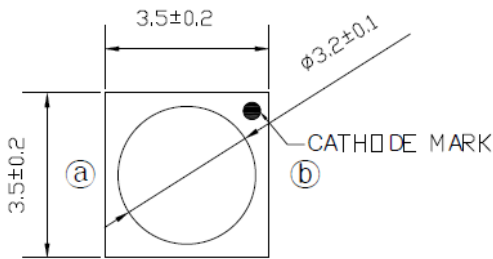

Bottom View

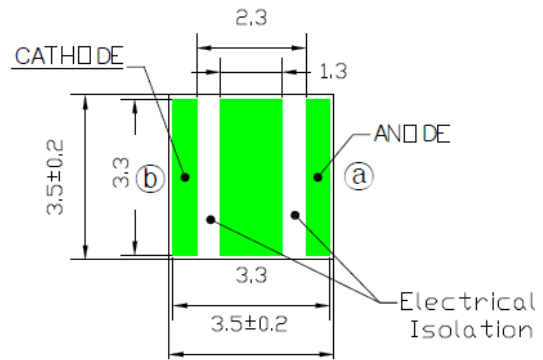

Side View

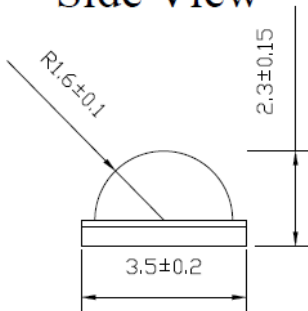

Circuit

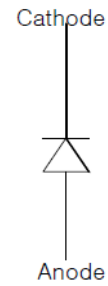

- (1) All dimensions are in millimeters.
- (2) Scale : none
- (3) Undefined tolerance is  $\pm 0.1$ mm





## Reflow Soldering Characteristics

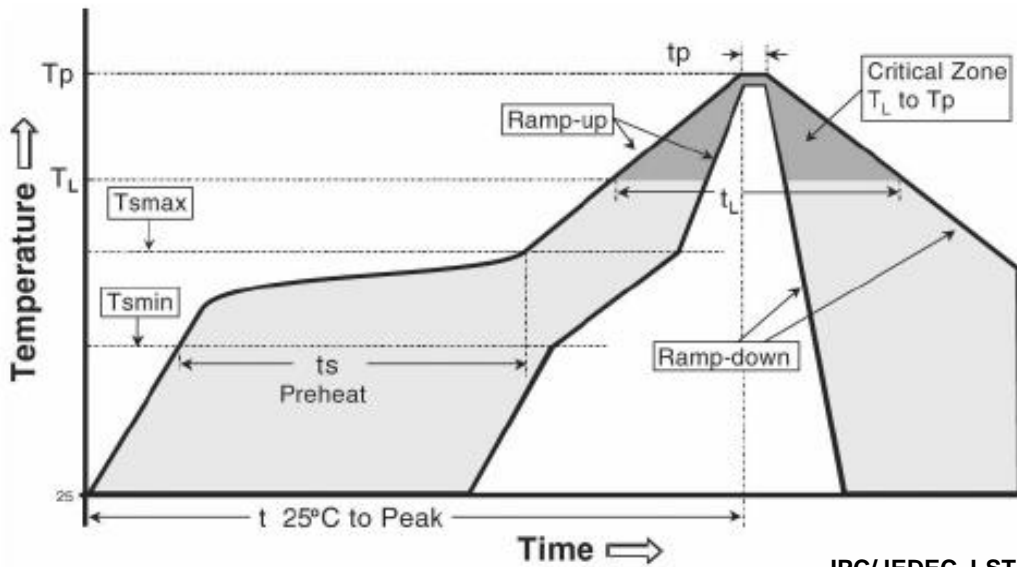

**IPC/JEDEC J-STD-020**

Profile Feature	Sn-Pb Eutectic Assembly	Pb-Free Assembly
Average ramp-up rate (T <sub>smax</sub> to T <sub>p</sub> )	3° C/second max.	3° C/second max.
Preheat - Temperature Min (T <sub>smin</sub> ) - Temperature Max (T <sub>smax</sub> ) - Time (T <sub>smin</sub> to T <sub>smax</sub> ) (t <sub>s</sub> )	100 °C 150 °C 60-120 seconds	150 °C 200 °C 60-180 seconds
Time maintained above: - Temperature (T <sub>L</sub> ) - Time (t <sub>L</sub> )	183 °C 60-150 seconds	217 °C 60-150 seconds
Peak Temperature (T <sub>p</sub> )	215°C	260°C
Time within 5°C of actual Peak Temperature (t <sub>p</sub> ) <sup>2</sup>	10-30 seconds	20-40 seconds
Ramp-down Rate	6 °C/second max.	6 °C/second max.
Time 25°C to Peak Temperature	6 minutes max.	8 minutes max.

### Caution

- (1) Reflow soldering is recommended not to be done more than two times. In the case of more than 24 hours passed soldering after first, LEDs will be damaged.
- (2) Repairs should not be done after the LEDs have been soldered. When repair is unavoidable, suitable tools must be used.
- (3) Die slug is to be soldered.
- (4) When soldering, do not put stress on the LEDs during heating.
- (5) After soldering, do not warp the circuit board.
- (6) For this LED, it is recommended to set the reflow peak temperature at 250~260°C based on real temperature because of complete soldering.

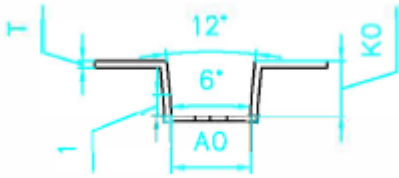
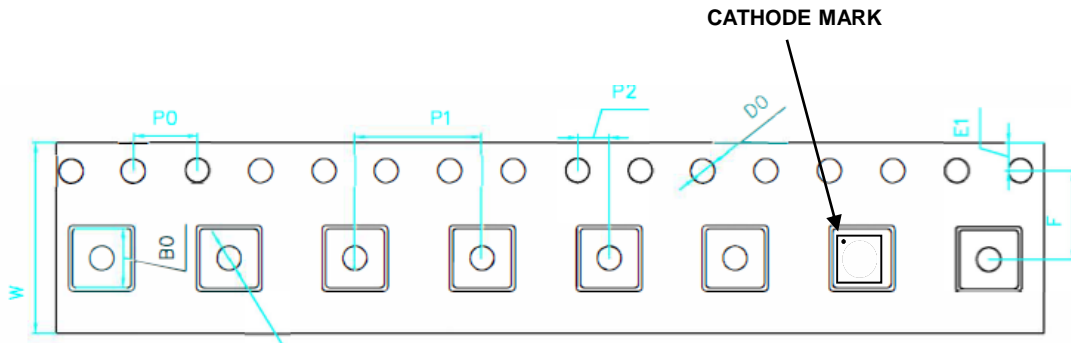
## Emitter Tape & Reel Packaging



P0	4.00±0.10
P1	8.00±0.10
P2	2.00±0.10
E1	1.75±0.10
F1	5.50±0.10
D0	1.50±0.10-0.0
D1	1.50±0.10
T	0.30±0.05
W	12.00±0.30

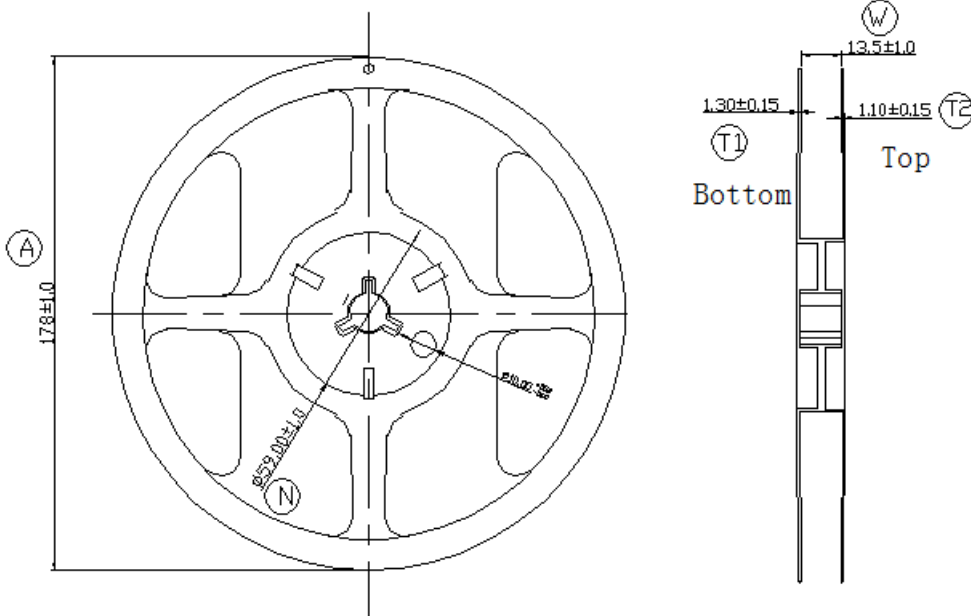

### Notes :

- Quantity : 900pcs/Reel
- Cumulative Tolerance : Cumulative Tolerance/10 pitches to be  $\pm 0.2\text{mm}$
- Adhesion Strength of Cover Tape : Adhesion strength to be 10-60g when the cover tape is turned off from the carrier tape at the angle of  $10^\circ$  to the carrier tape
- Package : P/N, Manufacturing data Code No. and quantity to be indicated on a damp proof Package

## Packaging Information

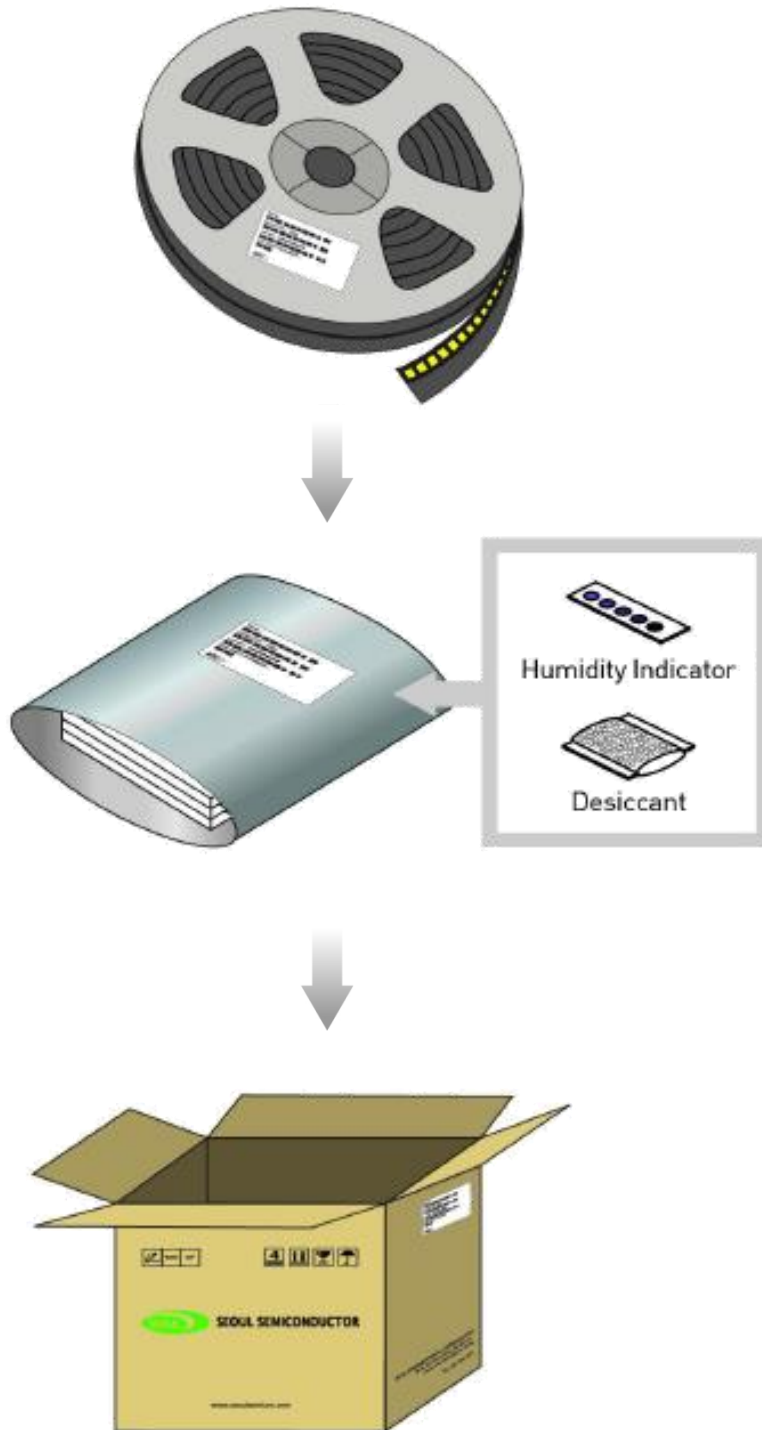

## Product Nomenclature

**Table 6. Part Numbering System :**

Part Number Code	Description	Part Number	Value
X <sub>1</sub>	Company	S	Seoul Semiconductor
X <sub>2</sub>	Level of Integration	1	Discrete LED
X <sub>3</sub> X <sub>4</sub>	Technology	W0	General White
X <sub>5</sub> X <sub>6</sub> X <sub>7</sub> X <sub>8</sub>	Dimension	3535	
X <sub>9</sub> X <sub>10</sub>	CCT	40	
X <sub>11</sub> X <sub>12</sub>	CRI	70	
X <sub>13</sub> X <sub>14</sub>	Vf	03	
X <sub>15</sub> X <sub>16</sub> X <sub>17</sub>	Characteristic code Flux Rank	000	
X <sub>18</sub> X <sub>19</sub> X <sub>20</sub>	Characteristic code Vf Rank	000	
X <sub>21</sub> X <sub>22</sub>	Characteristic code Color Step	00	
X <sub>23</sub> X <sub>24</sub>	Type	00	
X <sub>25</sub> X <sub>26</sub> X <sub>27</sub>	Internal code	002	

## Handling of Silicone Resin for LEDs

- (1) During processing, mechanical stress on the surface should be minimized as much as possible. Sharp objects of all types should not be used to pierce the sealing compound.

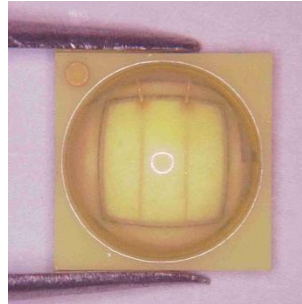
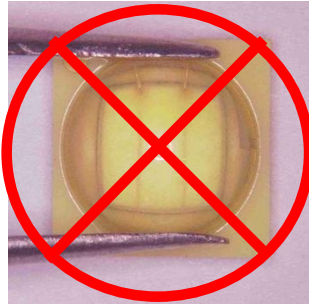

- (2) In general, LED should only be handled from the side. By the way, this also applies to LED without a silicone sealant, since the surface can also become scratched.
- (3) When populating boards in SMT production, there are basically no restrictions regarding the form of the pick and place nozzle, except that mechanical pressure on the surface of the resin must be prevented. This is assured by choosing a pick and place nozzle which is larger than the LED's reflector area.
- (4) Silicone differs from materials conventionally used for the manufacturing of LEDs. These conditions must be considered during the handling of such devices. Compared to standard encapsulants, silicone is generally softer, and the surface is more likely to attract dust. As mentioned previously, the increased sensitivity to dust requires special care during processing. In cases where a minimal level of dirt and dust particles cannot be guaranteed, a suitable cleaning solution must be applied to the surface after the soldering of components.
- (5) Seoul Semiconductor suggests using isopropyl alcohol for cleaning. In case other solvents are used, it must be assured that these solvents do not dissolve the package or resin. Ultrasonic cleaning is not recommended. Ultrasonic cleaning may cause damage to the LED.
- (6) Please do not mold this product into another resin (epoxy, urethane, etc) and do not handle this product with acid or sulfur material in sealed space.
- (7) Avoid leaving fingerprints on silicone resin parts.

## Precaution for Use

### (1) Storage

To avoid the moisture penetration, we recommend storing Z5 Series LED in a dry box with a desiccant. The recommended storage temperature range is 5°C to 30°C and a maximum humidity of RH50%.

### (2) Use Precaution after Opening the Packaging

Use SMT techniques properly when you solder the LED as separation of the lens may affect the light output efficiency.

Pay attention to the following:

#### a. Recommend conditions after opening the package

- Sealing / Temperature : 5 ~ 30°C Humidity : less than RH60%

#### b. If the package has been opened more than 4 weeks (MSL 2a) or the color of the desiccant changes, components should be dried for 10-24hr at 65±5°C

(3) Do not apply mechanical force or excess vibration during the cooling process to normal temperature after soldering.

(4) Do not rapidly cool device after soldering.

(5) Components should not be mounted on warped (non coplanar) portion of PCB.

(6) Radioactive exposure is not considered for the products listed here in.

(7) Gallium arsenide is used in some of the products listed in this publication. These products are dangerous if they are burned or shredded in the process of disposal. It is also dangerous to drink the liquid or inhale the gas generated by such products when chemically disposed of.

(8) This device should not be used in any type of fluid such as water, oil, organic solvent and etc. When washing is required, IPA (Isopropyl Alcohol) should be used.

(9) When the LED are in operation the maximum current should be decided after measuring the package temperature.

(10) The appearance and specifications of the product may be modified for improvement without notice.

(11) Long time exposure of sunlight or occasional UV exposure will cause lens discoloration.

## Precaution for Use

(12) VOCs (Volatile organic compounds) emitted from materials used in the construction of fixtures can penetrate silicone encapsulants of LED and discolor when exposed to heat and photonic energy. The result can be a significant loss of light output from the fixture. Knowledge of the properties of the materials selected to be used in the construction of fixtures can help prevent these issues.

(13) Attaching LEDs, do not use adhesives that outgas organic vapor.

(14) The driving circuit must be designed to allow forward voltage only when it is ON or OFF. If the reverse voltage is applied to LED, migration can be generated resulting in LED damage.

(15) LED is sensitive to Electro-Static Discharge (ESD) and Electrical Over Stress (EOS). Below is a list of suggestions that Seoul Semiconductor purposes to minimize these effects.

### a. ESD (Electro Static Discharge)

Electrostatic discharge (ESD) is defined as the release of static electricity when two objects come into contact. While most ESD events are considered harmless, it can be an expensive problem in many industrial environments during production and storage. The damage from ESD to an LED may cause the product to demonstrate unusual characteristics such as:

- Increase in reverse leakage current lowered turn-on voltage
- Abnormal emissions from the LED at low current

The following recommendations are suggested to help minimize the potential for an ESD event.

One or more recommended work area suggestions:

- Ionizing fan setup
- ESD table/shelf mat made of conductive materials
- ESD safe storage containers

One or more personnel suggestion options:

- Antistatic wrist-strap
- Antistatic material shoes
- Antistatic clothes

Environmental controls:

- Humidity control (ESD gets worse in a dry environment)

## Precaution for Use

### b. EOS (Electrical Over Stress)

Electrical Over-Stress (EOS) is defined as damage that may occur when an electronic device is subjected to a current or voltage that is beyond the maximum specification limits of the device. The effects from an EOS event can be noticed through product performance like:

- Changes to the performance of the LED package  
(If the damage is around the bond pad area and since the package is completely encapsulated the package may turn on but flicker show severe performance degradation.)
- Changes to the light output of the luminaire from component failure
- Components on the board not operating at determined drive power

Failure of performance from entire fixture due to changes in circuit voltage and current across total circuit causing trickle down failures. It is impossible to predict the failure mode of every LED exposed to electrical overstress as the failure modes have been investigated to vary, but there are some common signs that will indicate an EOS event has occurred:

- Damaged may be noticed to the bond wires (appearing similar to a blown fuse)
- Damage to the bond pads located on the emission surface of the LED package  
(shadowing can be noticed around the bond pads while viewing through a microscope)
- Anomalies noticed in the encapsulation and phosphor around the bond wires.
- This damage usually appears due to the thermal stress produced during the EOS event.

### c. To help minimize the damage from an EOS event Seoul Semiconductor recommends utilizing:

- A surge protection circuit
- An appropriately rated over voltage protection device
- A current limiting device





## **Company Information**

### **Published by**

Seoul Semiconductor © 2013 All Rights Reserved.

### **Company Information**

Seoul Semiconductor ([www.SeoulSemicon.com](http://www.SeoulSemicon.com)) manufactures and packages a wide selection of light emitting diodes (LEDs) for the automotive, general illumination/lighting, Home appliance, signage and back lighting markets. The company is the world's fifth largest LED supplier, holding more than 10,000 patents globally, while offering a wide range of LED technology and production capacity in areas such as "nPola", "Acrich", the world's first commercially produced AC LED, and "Acrich MJT - Multi-Junction Technology" a proprietary family of high-voltage LEDs.

The company's broad product portfolio includes a wide array of package and device choices such as Acrich and Acirch2, high-brightness LEDs, mid-power LEDs, side-view LEDs, and through-hole type LEDs as well as custom modules, displays, and sensors.

### **Legal Disclaimer**

Information in this document is provided in connection with Seoul Semiconductor products. With respect to any examples or hints given herein, any typical values stated herein and/or any information regarding the application of the device, Seoul Semiconductor hereby disclaims any and all warranties and liabilities of any kind, including without limitation, warranties of non-infringement of intellectual property rights of any third party. The appearance and specifications of the product can be changed to improve the quality and/or performance without notice.