

Integrated AC LED Solution

Acrich3 – 8.5W

SMJE-XV08W4P#

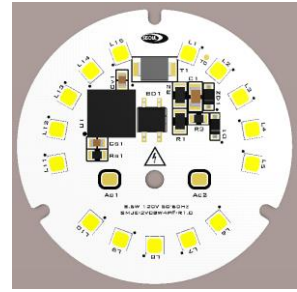

Product Brief

Description

- The Acrich3 series of products are designed to be driven directly off of AC line voltage, therefore they do not need the standard converter essential for conventional general lighting products.
- The converter or driver found in most general lighting products can limit the overall life of the product, but with the Acrich3 series of products the life of the product can more closely be estimated from the LED itself. This will also allow for a much smaller form factor from an overall fixture design allowing for higher creativity in the fixture.
- The modules have a high power factor which can contribute to a higher energy savings in the end application.

Features and Benefits

- Connects directly to AC line voltage though Acrich SPC (SPC P/N : SMJC-SPCACND)
- High Power Efficiency & Factor
- Low THD
- Long Life Time
- Simple BOM
- Miniaturization
- Lead Free Product
- RoHS Compliant

Key Applications

- Bulb Light
- Down Light
- Factory Ceiling Light
- Industrial Light

Table 1-1. Product Selection (CCT)

Part No.	Vin [Vac]	P [W]	Color	CCT [K]	CRI
					Min.
SMJE-2V08W4PD SMJE-3V08W4PD	120 230	8.5	Warm	2600 – 3200	80
			Neutral	3700 – 4200	
			Cool	4700 – 6000	
SMJE-2V08W4PE SMJE-3V08W4PE	120 230	8.5	Warm	2600 – 3200	90
			Neutral	3700 – 4200	
			Cool	4700 – 6000	

Table 1-2. Product Selection (Flux)

Part No.	Vin [Vac]	P [W]	Flux [lm]		Flux Bin
			Min.	Typ.	
SMJE-2V08W4PD SMJE-3V08W4PD	120 230	8.5	670	750	A75
			750	830	A83
SMJE-2V08W4PE SMJE-3V08W4PE	120 230	8.5	580	670	A67

Table of Contents

Index	
• Product Brief	
• Table of Contents	
• Performance Characteristics	
• Color Bin Structure	
• Part List	
• Mechanical Dimensions	
• Circuit Drawing	
• Marking Information	
• Packing & Label Information	
• Handling of Silicone Resin for LEDs	
• Precaution for Use	
• Company Information	

Performance Characteristics

Table 2. Electro Optical Characteristics, T_a = 25°C

Parameter	Symbol	Value			Unit	Mark
		Min.	Typ.	Max.		
Luminous Flux (CRI.80)	Φ_V [2]	670	750	-	lm	A75
		750	830	-		A83
Luminous Flux (CRI.90)		580	670	-		A67
Correlated Color Temperature [3]	CCT	5300	5600	6000	K	B
		4700	5000	5300		C
		3700	4000	4200		E
		2900	3000	3200		G
		2600	2700	2900		H
CRI	Ra	80	-	-	-	PD
		90	-	-	-	PE
Input Voltage [4]	V _{in}	120			Vac	2V
		230				3V
Power Consumption	P	7.7	8.5	9.3	W	08W
Operating Frequency	f	50 / 60			Hz	
Power Factor	PF	Over 0.90			-	
Viewing Angle	2 $\Theta_{1/2}$	120			deg.	
Tolerance of Surge [5]	V _s	500	-	-	V	
Transient Protection [6]	V _s	2500	-	-	V	

Notes :

- (1) At 120 / 230Vac, T_a = 25°C
- (2) Φ_V is the total luminous flux output measured with an integrated sphere.
(Measure tolerance : ±5%)
- (3) Correlated Color Temperature is derived from the CIE 1931 Chromaticity diagram.
- (4) Operating Voltage doesn't indicate the maximum voltage which customers use but means tolerable voltage according to each country's voltage variation rate. It is recommended that the solder pad temperature should be below 70°C.
- (5) Surge withstand in accordance with IEC61000-4-5
- (6) At 120Vac, seven strikes, 100kHz 2.5kV in accordance with ANSI/IEEE C62.41.2-2002 Category A operation

Absolute Maximum Ratings

Table 3. Absolute Maximum Ratings, $T_a = 25^\circ\text{C}$

Parameter	Symbol	Unit	Value
Maximum Input Voltage @120V	V_{in}	Vac	144
Maximum Input Voltage @230V			276
Power Consumption	P	W	9.7
Operating Temperature	T_{opr}	$^\circ\text{C}$	< 70
Storage Temperature	T_{stg}	$^\circ\text{C}$	-40 ~ 100
ESD Sensitivity	-	-	$\pm 4,000\text{V HBM}$

Thermal Resistance

Table 4. Thermal information, Ta = 25°C

Part	Maximum Junction Temperature [°C]	R θ_{j-s} [°C/W]
Acrich3 LED	125	9
Acrich3 IC	150	11.25

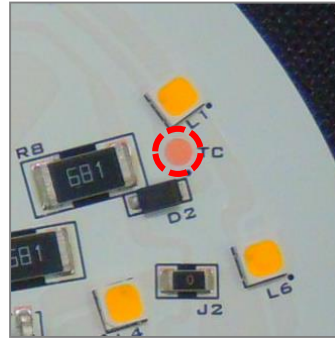
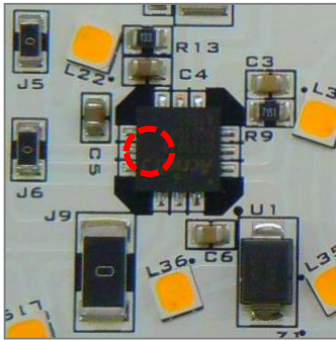
Notes :

The Acrich3 module is recommended to keep the junction temperature under maximum junction temperature spec. (Table 5)

LED lead temperature and IC top case temperature are measured with thermocouple. (Fig1)

LED & IC junction temperatures can be calculated using the formulas below.

$$T_{s_max} = T_{j_max} - (R\theta_{j-s} * P_d)$$

< Example >

If LED lead temperature and IC top temperature are 110°C

1) LED junction temperature

$$\begin{aligned} T_J &= T_S + (R\theta_{j-s} * P_d) \\ &= 110^\circ\text{C} + (9^\circ\text{C/W} * 0.84\text{W}) = 117.56^\circ\text{C} \end{aligned}$$

2) IC junction temperature

$$\begin{aligned} T_J &= T_S + (R\theta_{j-s} * P_d)^{(1)} \\ &= 110^\circ\text{C} + (11.25^\circ\text{C/W} * 2.8\text{W}) = 141.5^\circ\text{C} \end{aligned}$$

* (1) : In the example, P_d value is the power consumption of IC when the rated voltage.

Relative Spectral Distribution

Fig 1. Relative Spectral Distribution vs. Wavelength Characteristic – G, H

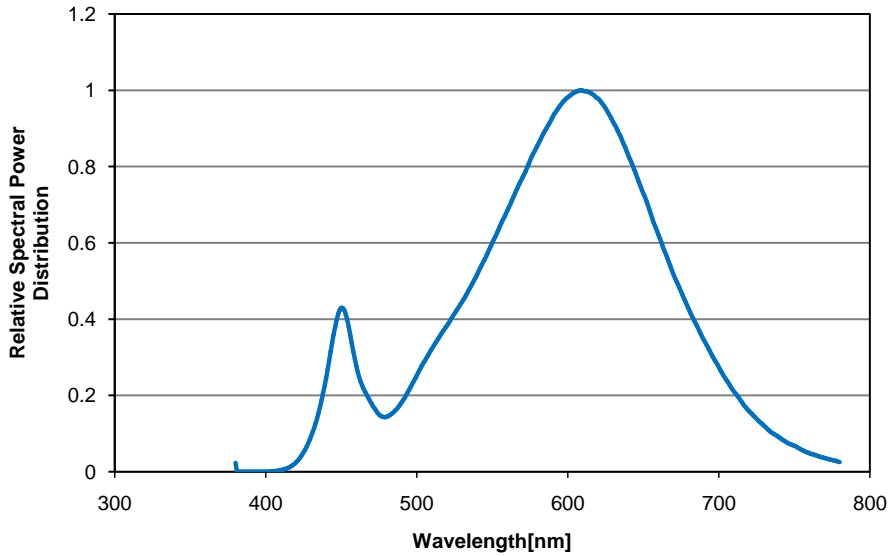
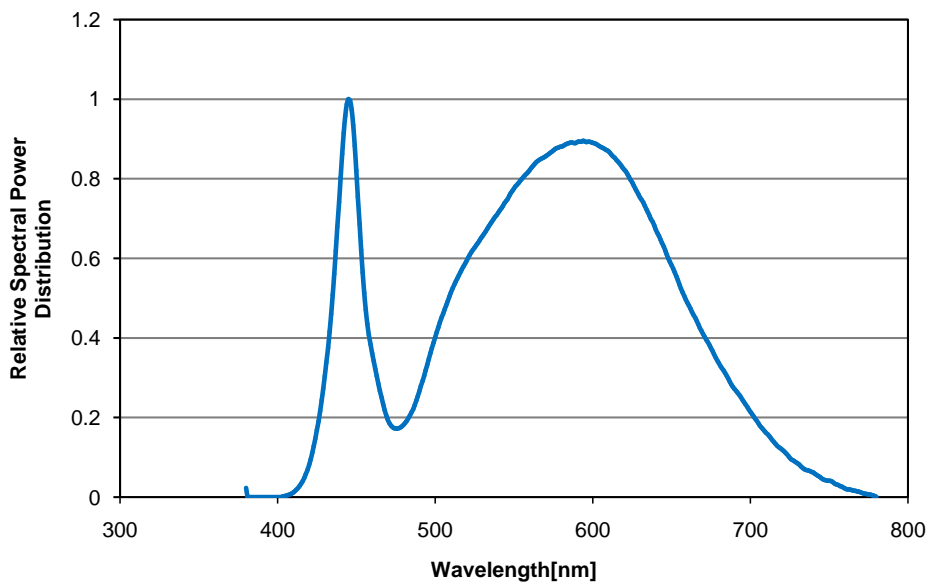
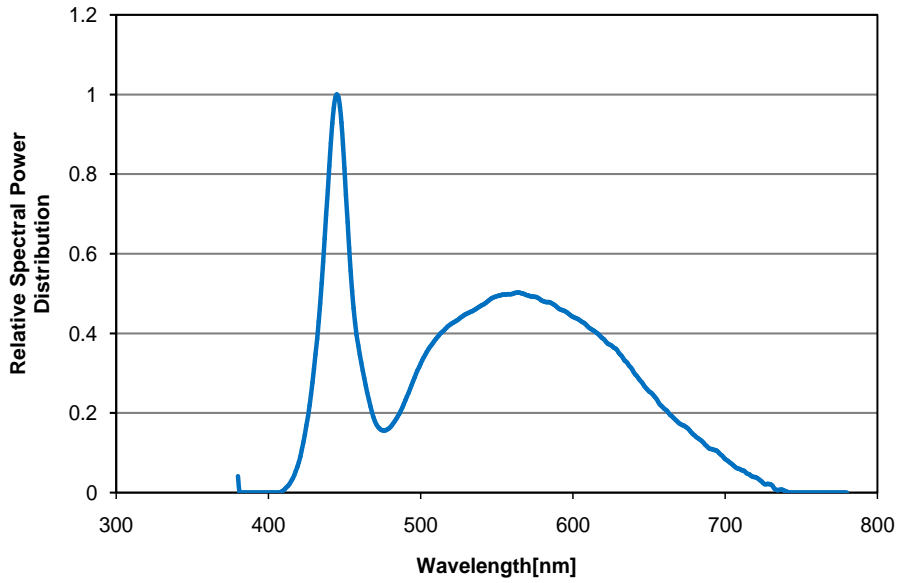

Fig 2. Relative Spectral Distribution vs. Wavelength Characteristic – E



Relative Spectral Distribution

Fig 3. Relative Spectral Distribution vs. Wavelength Characteristic – B, C



Relative Power Distribution

Fig 4. Relative Power Distribution vs. Voltage, $T_a=25^\circ\text{C}$, 120V

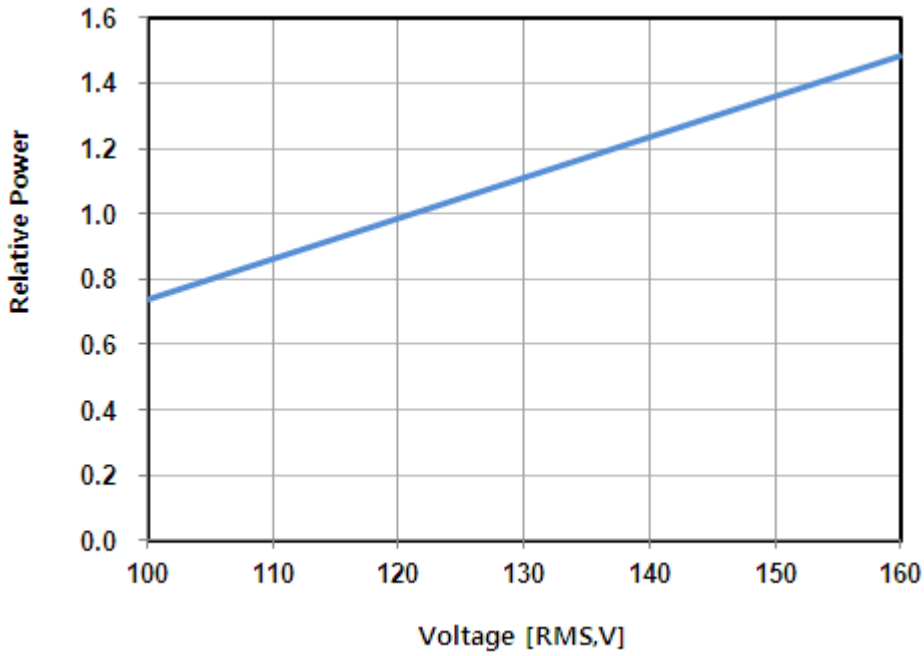
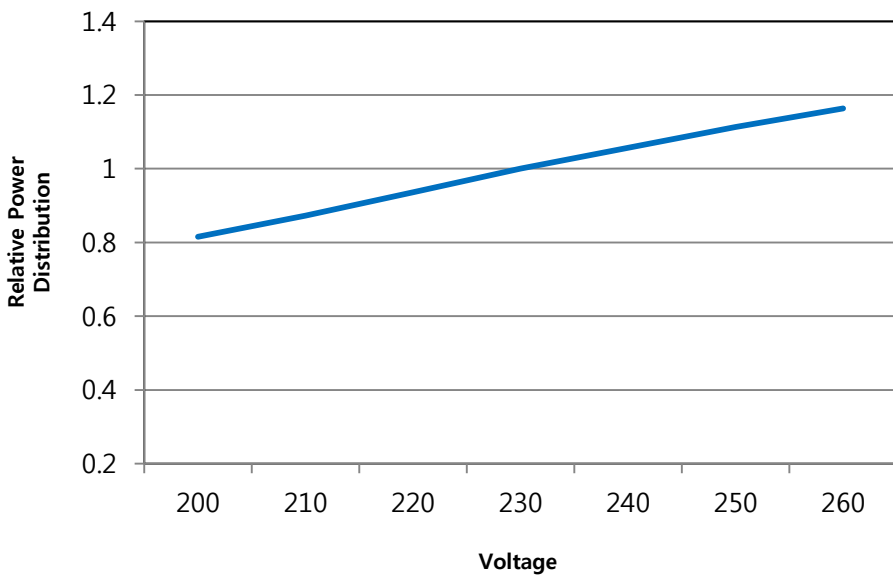

Fig 5. Relative Power Distribution vs. Voltage, $T_a=25^\circ\text{C}$, 230V



Relative Luminous Distribution

Fig 6. Relative Luminous Flux vs. Voltage, $T_a = 25^\circ\text{C}$, 120V

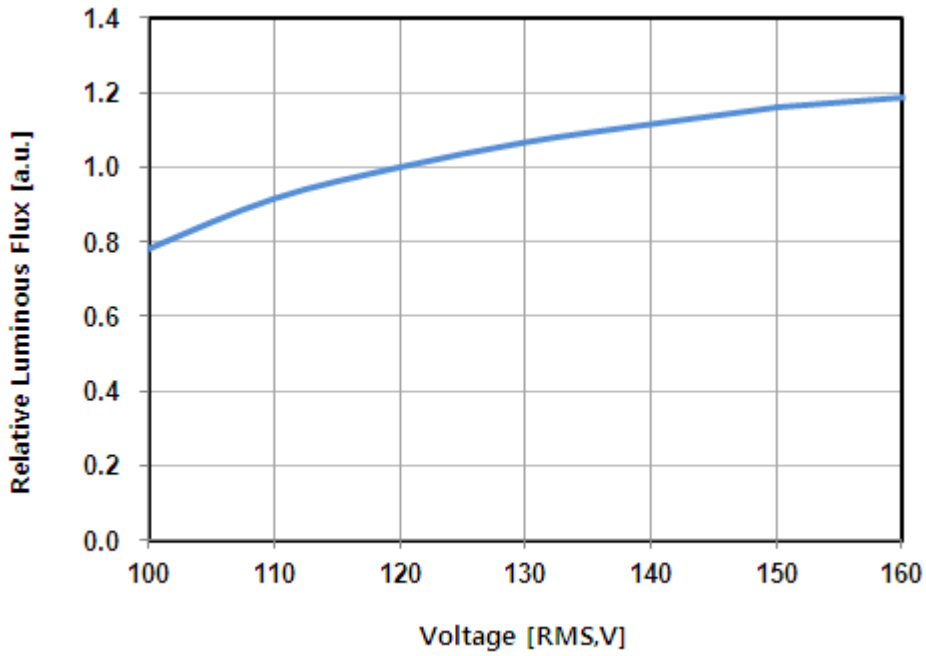
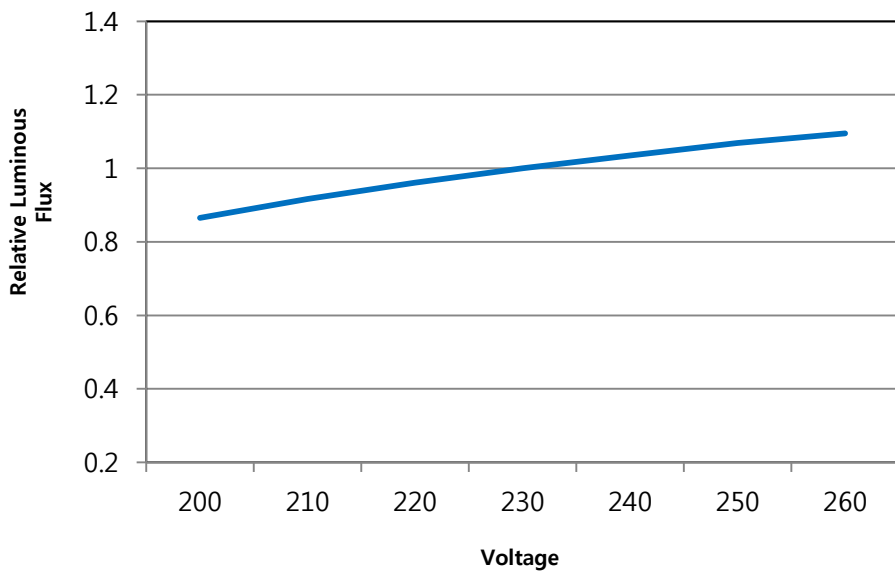
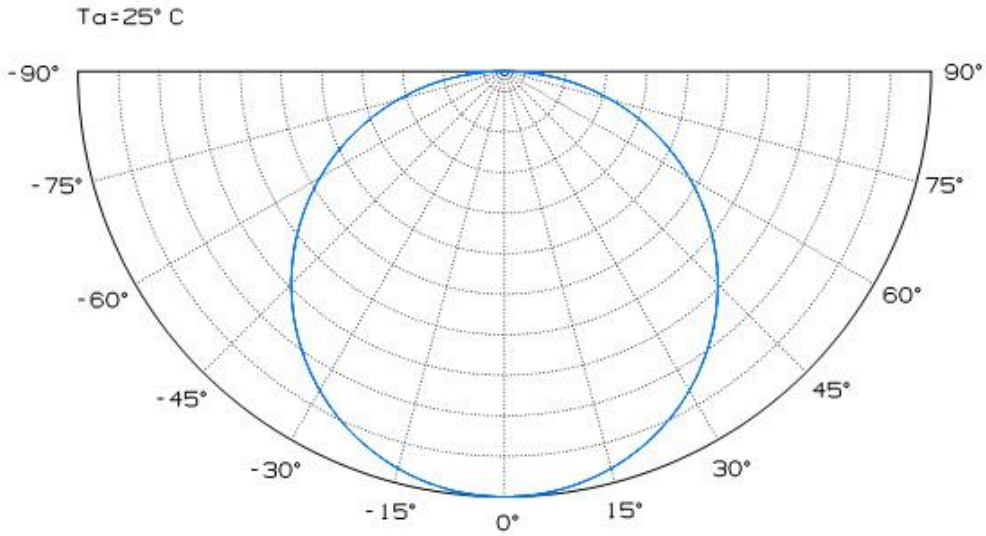

Fig 7. Relative Luminous Flux vs. Voltage, $T_a = 25^\circ\text{C}$, 230V



Luminous Flux Characteristics

Fig 8. Radiant Pattern, $T_a=25^{\circ}\text{C}$



Color Bin Structure

CIE Chromaticity Diagram

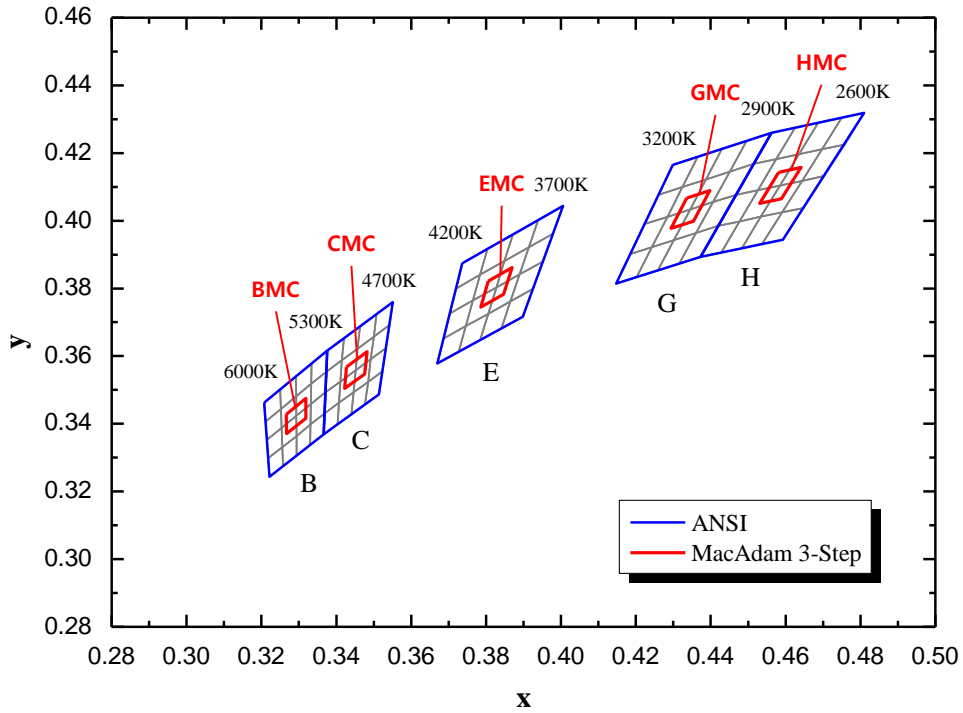

Bin	x	y	Bin	x	y	Bin	x	y
BMC	0.3266	0.3428	CMC	0.3427	0.3568	EMC	0.3806	0.3822
	0.3268	0.3371		0.3423	0.3504		0.3786	0.3745
	0.3319	0.3416		0.3476	0.3547		0.3846	0.3782
	0.3319	0.3476		0.3482	0.3613		0.3870	0.3861
GMC	0.4336	0.4067	HMC	0.4581	0.4143			
	0.4294	0.3977		0.4531	0.4051			
	0.4354	0.3999		0.4589	0.4065			
	0.4398	0.4089		0.4641	0.4157			

Color Bin Structure

CIE Chromaticity Diagram

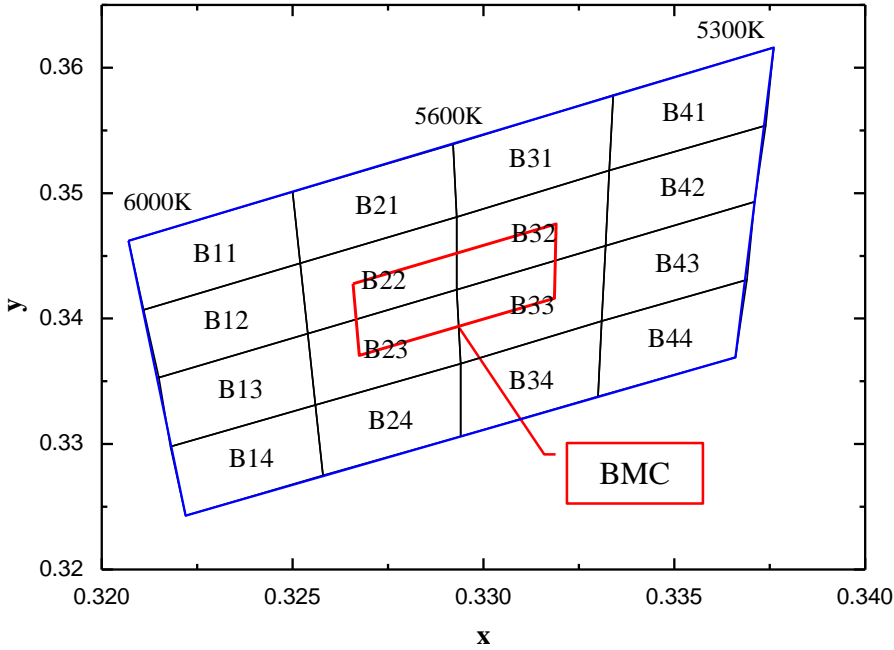

Bin	x	y	Bin	x	y	Bin	x	y	Bin	x	y
B11	0.3207	0.3462	B21	0.3250	0.3501	B31	0.3292	0.3539	B41	0.3334	0.3578
	0.3211	0.3407		0.3252	0.3444		0.3293	0.3481		0.3333	0.3518
	0.3252	0.3444		0.3293	0.3481		0.3333	0.3518		0.3374	0.3554
	0.3250	0.3501		0.3292	0.3539		0.3334	0.3578		0.3376	0.3616
B12	0.3211	0.3407	B22	0.3252	0.3444	B32	0.3293	0.3481	B42	0.3333	0.3518
	0.3215	0.3353		0.3254	0.3388		0.3293	0.3423		0.3332	0.3458
	0.3254	0.3388		0.3293	0.3423		0.3332	0.3458		0.3371	0.3493
	0.3252	0.3444		0.3293	0.3481		0.3333	0.3518		0.3374	0.3554
B13	0.3215	0.3353	B23	0.3254	0.3388	B33	0.3293	0.3423	B43	0.3332	0.3458
	0.3218	0.3298		0.3256	0.3331		0.3294	0.3364		0.3331	0.3398
	0.3256	0.3331		0.3294	0.3364		0.3331	0.3398		0.3369	0.3431
	0.3254	0.3388		0.3293	0.3423		0.3332	0.3458		0.3371	0.3493
B14	0.3218	0.3298	B24	0.3256	0.3331	B34	0.3294	0.3364	B44	0.3331	0.3398
	0.3222	0.3243		0.3258	0.3275		0.3294	0.3306		0.3330	0.3338
	0.3258	0.3275		0.3294	0.3306		0.3330	0.3338		0.3366	0.3369
	0.3256	0.3331		0.3294	0.3364		0.3331	0.3398		0.3369	0.3431

Color Bin Structure

CIE Chromaticity Diagram

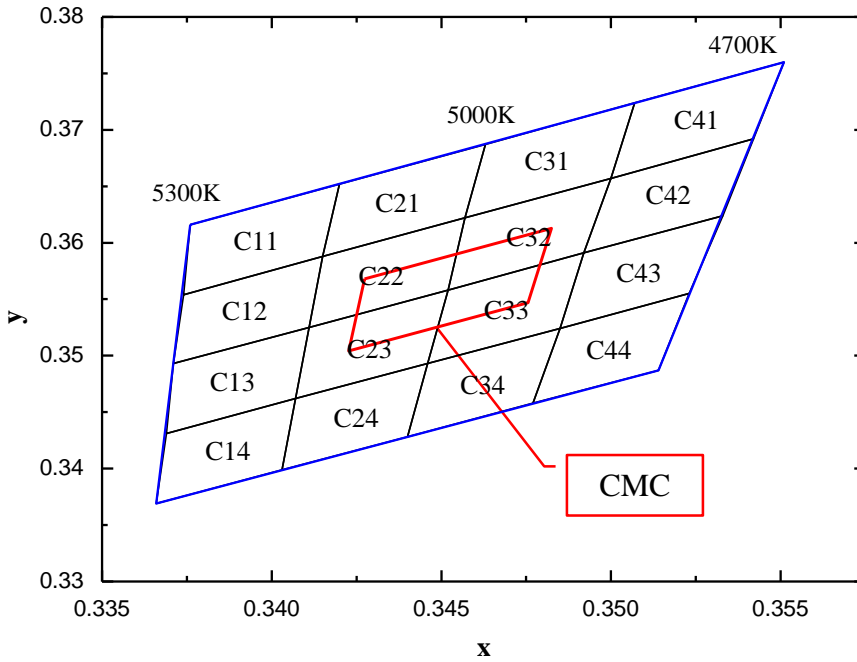

Bin	x	y	Bin	x	y	Bin	x	y	Bin	x	y
C11	0.3376	0.3616	C21	0.3420	0.3652	C31	0.3463	0.3687	C41	0.3507	0.3724
	0.3374	0.3554		0.3415	0.3588		0.3457	0.3622		0.3500	0.3657
	0.3415	0.3588		0.3457	0.3622		0.3500	0.3657		0.3542	0.3692
	0.3420	0.3652		0.3463	0.3687		0.3507	0.3724		0.3551	0.3760
C12	0.3374	0.3554	C22	0.3415	0.3588	C32	0.3457	0.3622	C42	0.3500	0.3657
	0.3371	0.3493		0.3411	0.3525		0.3452	0.3558		0.3492	0.3591
	0.3411	0.3525		0.3452	0.3558		0.3492	0.3591		0.3533	0.3624
	0.3415	0.3588		0.3457	0.3622		0.3500	0.3657		0.3542	0.3692
C13	0.3371	0.3493	C23	0.3411	0.3525	C33	0.3452	0.3558	C43	0.3492	0.3591
	0.3369	0.3431		0.3407	0.3462		0.3446	0.3493		0.3485	0.3524
	0.3407	0.3462		0.3446	0.3493		0.3485	0.3524		0.3523	0.3555
	0.3411	0.3525		0.3452	0.3558		0.3492	0.3591		0.3533	0.3624
C14	0.3369	0.3431	C24	0.3407	0.3462	C34	0.3446	0.3493	C44	0.3485	0.3524
	0.3366	0.3369		0.3403	0.3399		0.3440	0.3428		0.3477	0.3458
	0.3403	0.3399		0.3440	0.3428		0.3477	0.3458		0.3514	0.3487
	0.3407	0.3462		0.3446	0.3493		0.3485	0.3524		0.3523	0.3555

Color Bin Structure

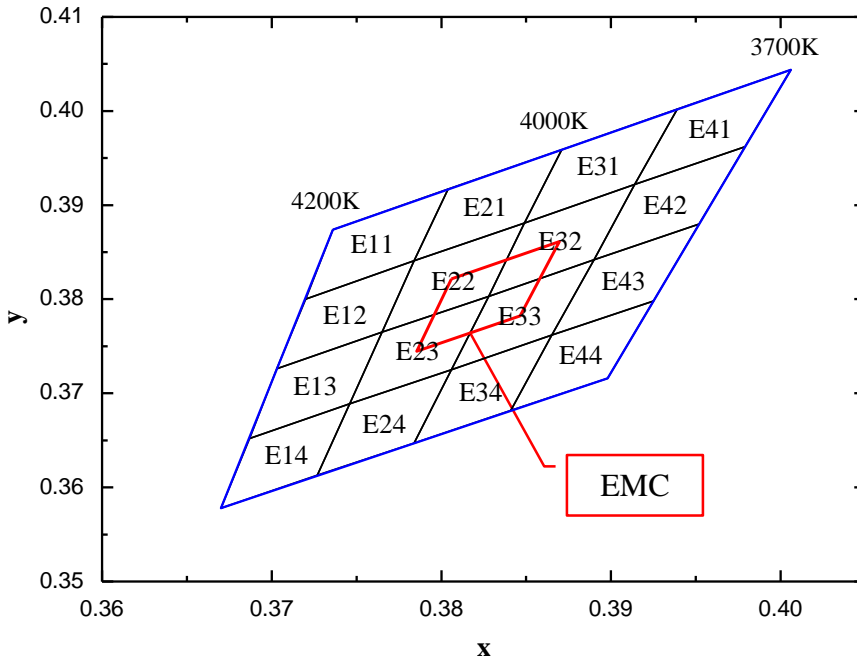
CIE Chromaticity Diagram

Bin	x	y	Bin	x	y	Bin	x	y	Bin	x	y
E11	0.3736	0.3874	E21	0.3804	0.3917	E31	0.3871	0.3959	E41	0.3939	0.4002
	0.3720	0.3800		0.3784	0.3841		0.3849	0.3881		0.3914	0.3922
	0.3784	0.3841		0.3849	0.3881		0.3914	0.3922		0.3979	0.3962
	0.3804	0.3917		0.3871	0.3959		0.3939	0.4002		0.4006	0.4044
E12	0.3720	0.3800	E22	0.3784	0.3841	E32	0.3849	0.3881	E42	0.3914	0.3922
	0.3703	0.3726		0.3765	0.3765		0.3828	0.3803		0.3890	0.3842
	0.3765	0.3765		0.3828	0.3803		0.3890	0.3842		0.3952	0.3880
	0.3784	0.3841		0.3849	0.3881		0.3914	0.3922		0.3979	0.3962
E13	0.3703	0.3726	E23	0.3765	0.3765	E33	0.3828	0.3803	E43	0.3890	0.3842
	0.3687	0.3652		0.3746	0.3689		0.3806	0.3725		0.3865	0.3762
	0.3746	0.3689		0.3806	0.3725		0.3865	0.3762		0.3925	0.3798
	0.3765	0.3765		0.3828	0.3803		0.3890	0.3842		0.3952	0.3880
E14	0.3687	0.3652	E24	0.3746	0.3689	E34	0.3806	0.3725	E44	0.3865	0.3762
	0.3670	0.3578		0.3727	0.3613		0.3784	0.3647		0.3841	0.3682
	0.3727	0.3613		0.3784	0.3647		0.3841	0.3682		0.3898	0.3716
	0.3746	0.3689		0.3806	0.3725		0.3865	0.3762		0.3925	0.3798

Color Bin Structure

CIE Chromaticity Diagram

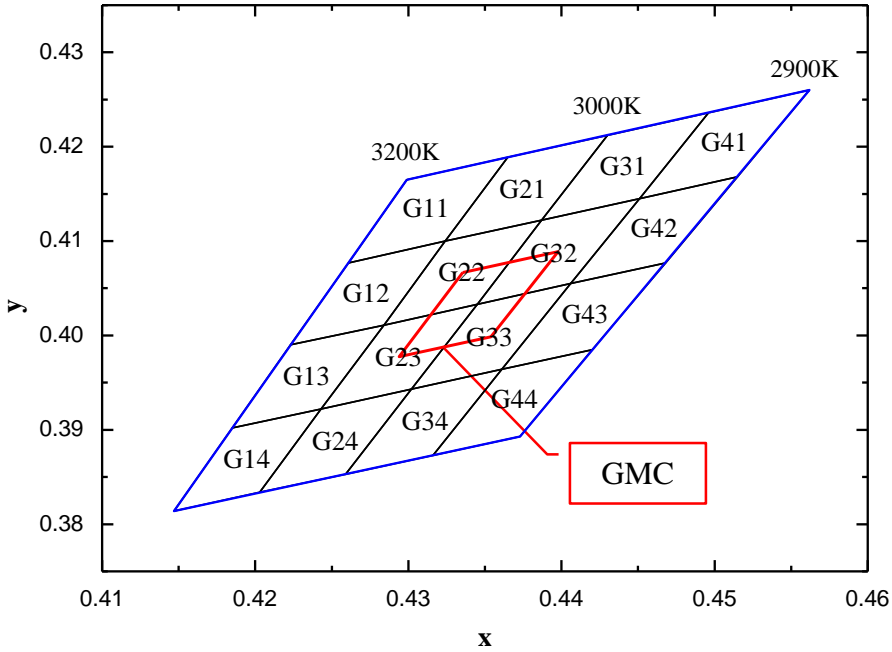

Bin	x	y	Bin	x	y	Bin	x	y	Bin	x	y
G11	0.4299	0.4165	G21	0.4364	0.4188	G31	0.4430	0.4212	G41	0.4496	0.4236
	0.4261	0.4077		0.4324	0.4099		0.4387	0.4122		0.4451	0.4145
	0.4324	0.4100		0.4387	0.4122		0.4451	0.4145		0.4514	0.4168
	0.4365	0.4189		0.4430	0.4212		0.4496	0.4236		0.4562	0.4260
G12	0.4261	0.4077	G22	0.4324	0.4100	G32	0.4387	0.4122	G42	0.4451	0.4145
	0.4223	0.3990		0.4284	0.4011		0.4345	0.4033		0.4406	0.4055
	0.4284	0.4011		0.4345	0.4033		0.4406	0.4055		0.4468	0.4077
	0.4324	0.4100		0.4387	0.4122		0.4451	0.4145		0.4515	0.4168
G13	0.4223	0.3990	G23	0.4284	0.4011	G33	0.4345	0.4033	G43	0.4406	0.4055
	0.4185	0.3902		0.4243	0.3922		0.4302	0.3943		0.4361	0.3964
	0.4243	0.3922		0.4302	0.3943		0.4361	0.3964		0.4420	0.3985
	0.4284	0.4011		0.4345	0.4033		0.4406	0.4055		0.4468	0.4077
G14	0.4243	0.3922	G24	0.4302	0.3943	G34	0.4302	0.3943	G44	0.4361	0.3964
	0.4203	0.3834		0.4259	0.3853		0.4259	0.3853		0.4316	0.3873
	0.4147	0.3814		0.4203	0.3834		0.4316	0.3873		0.4373	0.3893
	0.4185	0.3902		0.4243	0.3922		0.4361	0.3964		0.4420	0.3985

Color Bin Structure

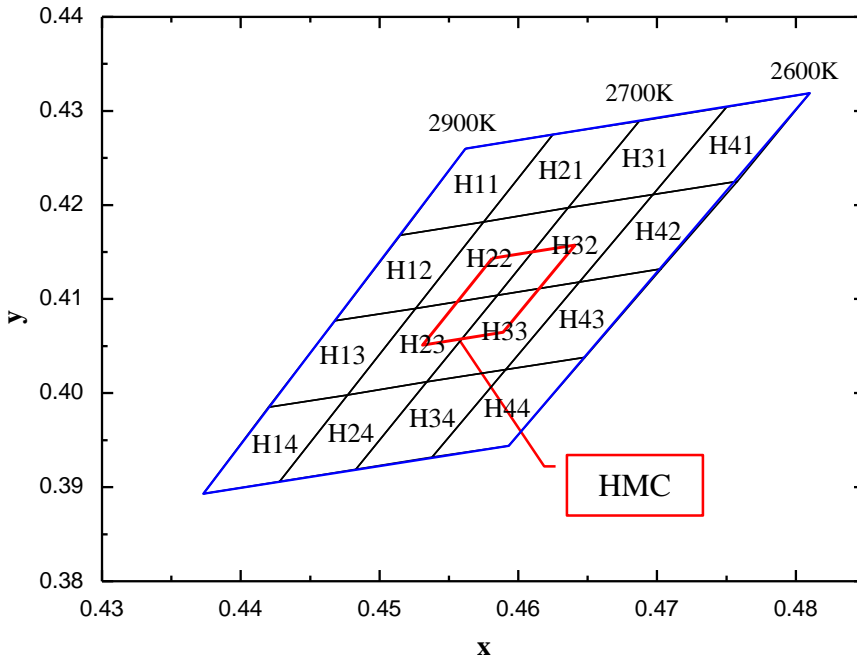
CIE Chromaticity Diagram

Bin	x	y	Bin	x	y	Bin	x	y	Bin	x	y
H11	0.4562	0.4260	H21	0.4625	0.4275	H31	0.4687	0.4289	H41	0.4750	0.4304
	0.4515	0.4168		0.4575	0.4182		0.4636	0.4197		0.4697	0.4211
	0.4575	0.4182		0.4636	0.4197		0.4697	0.4211		0.4758	0.4225
	0.4625	0.4275		0.4687	0.4289		0.4750	0.4304		0.4810	0.4319
H12	0.4515	0.4168	H22	0.4575	0.4182	H32	0.4636	0.4197	H42	0.4697	0.4211
	0.4468	0.4077		0.4526	0.4090		0.4585	0.4104		0.4644	0.4118
	0.4526	0.4090		0.4585	0.4104		0.4644	0.4118		0.4703	0.4132
	0.4575	0.4182		0.4636	0.4197		0.4697	0.4211		0.4758	0.4225
H13	0.4468	0.4077	H23	0.4526	0.4090	H33	0.4585	0.4104	H43	0.4644	0.4118
	0.4420	0.3985		0.4477	0.3998		0.4534	0.4012		0.4591	0.4025
	0.4477	0.3998		0.4534	0.4012		0.4591	0.4025		0.4648	0.4038
	0.4526	0.4090		0.4585	0.4104		0.4644	0.4118		0.4703	0.4132
H14	0.4420	0.3985	H24	0.4477	0.3998	H34	0.4534	0.4012	H44	0.4591	0.4025
	0.4373	0.3893		0.4428	0.3906		0.4483	0.3919		0.4538	0.3932
	0.4428	0.3906		0.4483	0.3919		0.4538	0.3932		0.4593	0.3944
	0.4477	0.3998		0.4534	0.4012		0.4591	0.4025		0.4648	0.4038

Mechanical Dimensions

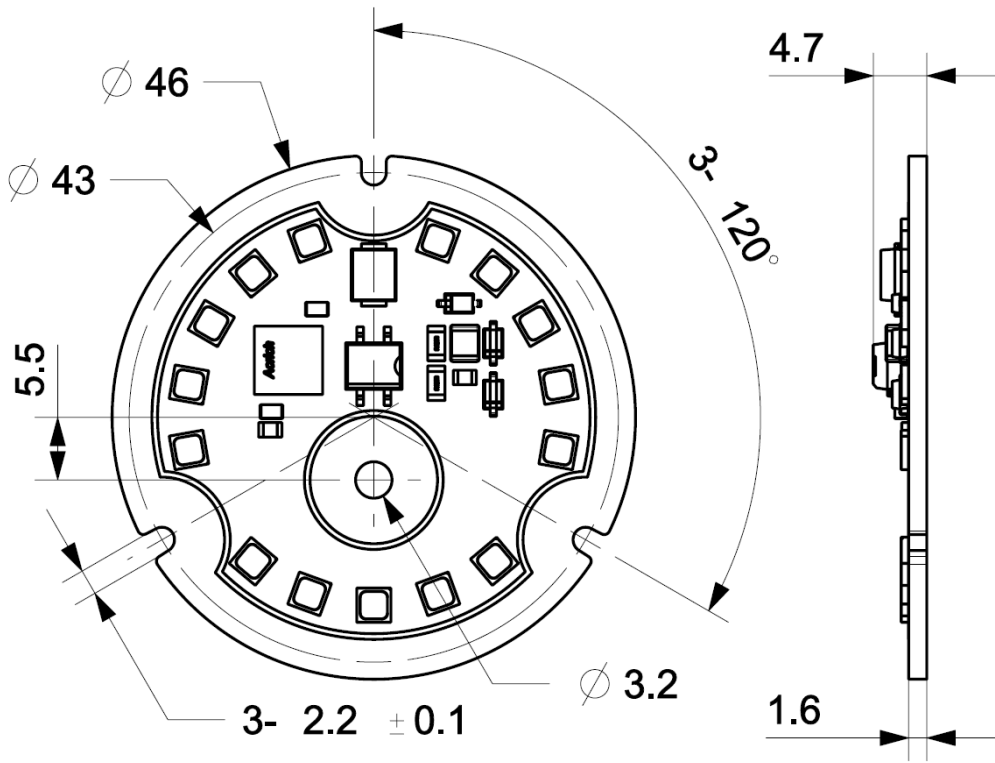
Notes :

- (1) All dimensions are in millimeters. (Tolerance : ± 0.2)
- (2) Scale : None

Marking Information

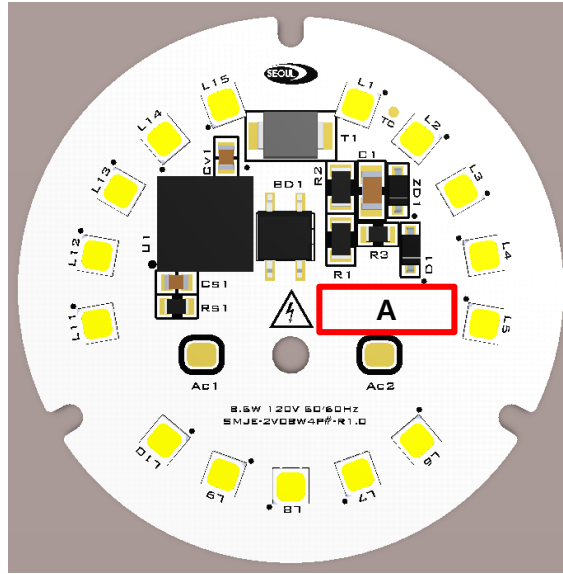

A : Marking Area

Fig 1. 2D Marking point

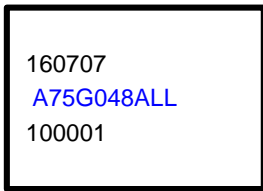

- ① SMT Date (YYMMDD, 6 Digits)
- ② MP Information (10 Digits)
- ③ Lot Number (6 Digits)

Table 1. MP information

A75G048ALL

①
②
③
④
⑤

FLUX	BIN
0lm	A
1000lm	B
2000lm	C
3000lm	D
4000lm	E
5000lm	F
6000lm	G
7000lm	H
8000lm	I
9000lm	J
10000lm	K
11000lm	L
12000lm	M
13000lm	N
14000lm	O

CCT
A~H

BIN*
0A
03
04
MC

CRI**
7
8
9

VF
ALL

* 0A : All Bin
 03 : Center 4bin Mixing(3-step)
 04 : Center 4bin Mixing(4-step)
 MC : XMC center 1Bin (3-step)

** 7 : CRI70
 8 : CRI80
 9 : CRI90

Packing

1. Tray information

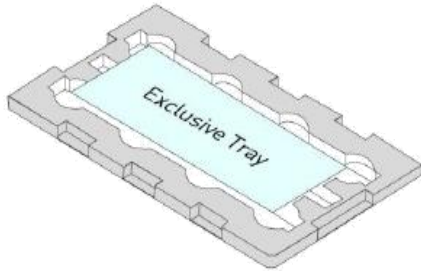

- 36 PCS LED modules packed per tray

2. Tray stack and taping

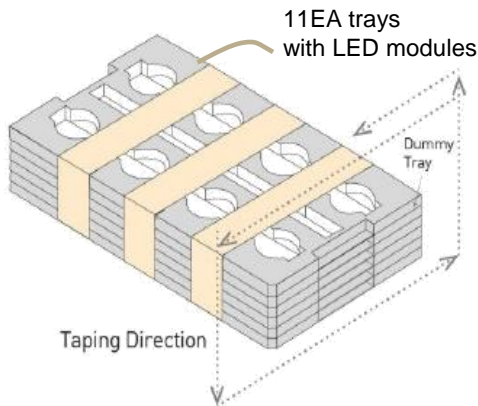

- 10 LED module trays and additional 1 dummy trays each up of box
- Add silica gel (1EA) on top of the tray

3. Sealing packing

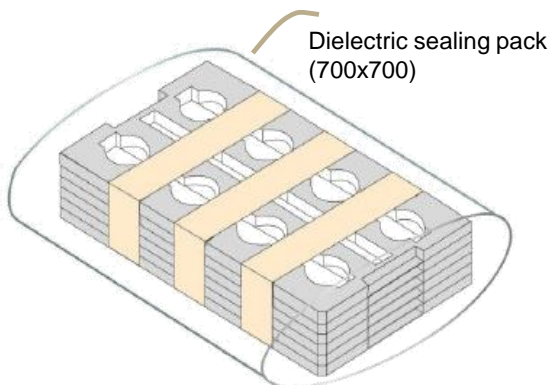

4. Box information & packing

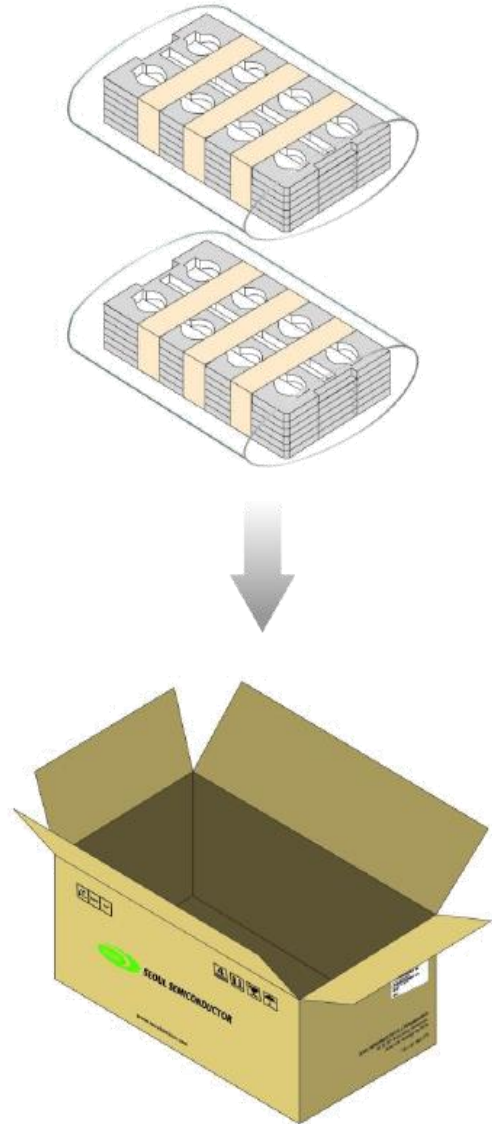

- 720 PCS modules per BOX 1EA

** 1Box : 36 PCS per tray x 20 trays = 720 PCS

Label Information

Model No.	SMJE-XV08W4PX (1)
Rank	AXXX0XXALL (2)
Type	STD / 3-Step (3)
Quantity	XX
Lot No.	YYMDDXXXXX-XXXXXXX
	SEOUL SEMICONDUCTOR CO.,LTD.

Notes

- (1) The model number designation is explained as follow
 SMJE : Seoul Semiconductor internal code
 XV : Input Voltage (2V = 120V, 3V = 230V)
 08W : Power Consumption
 4 : IC (Acrich3)
 PX : MJT PKG (PD = SAW8C72A, PE = SAW9C72A)
- (2) It represents the LED module rank.
 AXX : A75 / A83 / A67
 X : CCT (B, C, E, G, H)
 0X : McAdam Step (03, 04)
 X : 8 (8 = CRI.80), 9 (9 = CRI.90)
 ALL : VF All
- (3) It represents McAdam 4-Step(STD) and McAdam 3-Step(3-Step)
- (4) It is attached to the top of a sealing pack & the bottom right corner of the box.

<p>TOTAL Quantity</p> <p> </p> <p>XXX</p>
 SEOUL SEMICONDUCTOR CO.,LTD.

Notes

- (1) It is attached to the bottom right corner of the box.

Precaution for Use

- (1) Please review the Acrich3 Application Note for proper protective circuitry usage.
- (2) Please note, Acrich3 products run off of high voltage, therefore caution should be taken when working near Acrich3 products.
- (3) Make sure proper discharge prior to starting work.
- (4) DO NOT touch any of the circuit board, components or terminals with body or metal while circuit is active.
- (5) Please do not add or change wires while Acrich3 circuit is active.
- (6) Long time exposure to sunlight or UV can cause the lens to discolor.
- (7) Please do not use adhesives to attach the LED that outgas organic vapor.
- (8) Please do not use together with the materials containing Sulfur.
- (9) Please do not assemble in conditions of high moisture and/or oxidizing gas such as Cl, H₂S, NH₃, SO₂, NO_x, etc.
- (10) Please do not make any modification on module.
- (11) Please be cautious when soldering to board so as not to create a short between different trace patterns.
- (12) Do not impact or place pressure on this product because even a small amount of pressure can damage the product. The product should also not be placed in high temperatures, high humidity or direct sunlight since the device is sensitive to these conditions.
- (13) When storing devices for a long period of time before usage, please following these guidelines:
 - * The devices should be stored in the anti-static bag that it was shipped in from Seoul-Semiconductor with opening.
 - * If the anti-static bag has been opened, re-seal preventing air and moisture from being present in the bag.
- (14) LEDs and IC are sensitive to Electro-Static Discharge (ESD) and Electrical Over Stress (EOS). The Acrich3 product should also not be installed in end equipment without ESD protection. Below is a list of suggestions that Seoul Semiconductor purposes to minimize these effects.

a. ESD (Electro Static Discharge)

Electrostatic discharge (ESD) is the defined as the release of static electricity when two objects come into contact. While most ESD events are considered harmless, it can be an expensive problem in many industrial environments during production and storage. The damage from ESD to an LEDs may cause the product to demonstrate unusual characteristics such as:

Precaution for Use

- Increase in reverse leakage current lowered turn-on voltage
- Abnormal emissions from the LED at low current

The following recommendations are suggested to help minimize the potential for an ESD event. One or more recommended work area suggestions:

- Ionizing fan setup
- ESD table/shelf mat made of conductive materials
- ESD safe storage containers

One or more personnel suggestion options:

- Antistatic wrist-strap
- Antistatic material shoes
- Antistatic clothes

Environmental controls:

- Humidity control (ESD gets worse in a dry environment)

b. EOS (Electrical Over Stress)

Electrical Over-Stress (EOS) is defined as damage that may occur when an electronic device is subjected to a current or voltage that is beyond the maximum specification limits of the device. The effects from an EOS event can be noticed through product performance like:

- Changes to the performance of the LED package
(If the damage is around the bond pad area and since the package is completely encapsulated the package may turn on but flicker show severe performance degradation.)
- Changes to the light output of the luminaire from component failure
- Components on the board not operating at determined drive power

Failure of performance from entire fixture due to changes in circuit voltage and current across total circuit causing trickle down failures. It is impossible to predict the failure mode of every LED exposed to electrical overstress as the failure modes have been investigated to vary, but there are some common signs that will indicate an EOS event has occurred:

- Damaged may be noticed to the bond wires (appearing similar to a blown fuse)
- Damage to the bond pads located on the emission surface of the LED package
(shadowing can be noticed around the bond pads while viewing through a microscope)
- Anomalies noticed in the encapsulation and phosphor around the bond wires
- This damage usually appears due to the thermal stress produced during the EOS event

c. To help minimize the damage from an EOS event Seoul Semiconductor recommends utilizing:

- A surge protection circuit
- An appropriately rated over voltage protection device
- A current limiting device



Company Information

Published by

Seoul Semiconductor © 2013 All Rights Reserved.

Company Information

Seoul Semiconductor (www.SeoulSemicon.com) manufactures and packages a wide selection of light emitting diodes (LEDs) for the automotive, general illumination/lighting, Home appliance, signage and back lighting markets. The company is the world's fifth largest LED supplier, holding more than 10,000 patents globally, while offering a wide range of LED technology and production capacity in areas such as "nPola", "Acrich", the world's first commercially produced AC LED, and "Acrich MJT - Multi-Junction Technology" a proprietary family of high-voltage LEDs.

The company's broad product portfolio includes a wide array of package and device choices such as Acrich and Acirch2, high-brightness LEDs, mid-power LEDs, side-view LEDs, and through-hole type LEDs as well as custom modules, displays, and sensors.

Legal Disclaimer

Information in this document is provided in connection with Seoul Semiconductor products. With respect to any examples or hints given herein, any typical values stated herein and/or any information regarding the application of the device, Seoul Semiconductor hereby disclaims any and all warranties and liabilities of any kind, including without limitation, warranties of non-infringement of intellectual property rights of any third party. The appearance and specifications of the product can be changed to improve the quality and/or performance without notice.

Part List

Table 4-1. Part List (SMJE-3V08W4PD(PE))

No	Part	Reference	Specification	Quantity
1	PCB	-	AL-1.6T, Φ46, 1oz, Ventec VT-4B3S, PP180um, 3W/mK	1
2	LED	-	SAW8C72A (PD)	15
			SAW9C72A (PE)	
3	IC	U1	ICCH Acrich 3.0 Driver IC DT3007A	1
4	Bridge diode	BD1	BRIDGE SMD MB6S, 600V, 0.8A	1
5	Resistor	Rs1	RESI CHIP R2012, 7.5kΩ, 1%(F)	1
6		R1	RESI CHIP R3216, 1MΩ, 5%(J)	1
7		R2	RESI CHIP R3216, 2MΩ, 5%(J)	1
8		R3	RESI CHIP R2012, 2kΩ, 5%(J)	1
9	Diode	D1, D2	DIODE SMD RS1010FL-S, 900V, 1A	2
10	Capacitor	Cs1	CAPA CHIP C2012, 4.7nF, 25V, X7R, 10%(K)	1
11		C1	CAPA CHIP C3216, 10uF, 50V, X5R, 10%(K)	1
12		Cv1	CAPA CHIP C2012, 10uF, 25V, X7R, 10%(K)	1
13	TVS	T1	TVS SMD P6SMB200A, 200V, 600W	1
14	Zener-Diode	ZD1	DIOD ZENER SMD BZT52-C20, 20Vdc, 410mW	1

Part List

Table 4-1. Part List (SMJE-2V08W4PD(PE))

No	Part	Reference	Specification	Quantity
1	PCB	-	AL-1.6T, Φ46, 1oz, Ventec VT-4B3S, PP180um, 3W/mK	1
2	LED	-	SAW8C72A (PD)	15
			SAW9C72A (PE)	
3	IC	U1	ICCH Acrich 3.0 Driver IC DT3007B	1
4	Bridge diode	BD1	BRIDGE SMD MB6S, 600V, 0.8A	1
5	Resistor	Rs1	RESI CHIP R2012, 7.5kΩ, 1%(F)	1
6		R1	RESI CHIP R3216, 200kΩ, 5%(J)	1
7		R2	RESI CHIP R3216, 330kΩ, 5%(J)	1
8		R3	RESI CHIP R2012, 1kΩ, 5%(J)	1
9	Diode	D1, D2	DIODE SMD RS1010FL-S, 900V, 1A	2
10	Capacitor	Cs1	CAPA CHIP C2012, 4.7nF, 25V, X7R, 10%(K)	1
11		C1	CAPA CHIP C3216, 10uF, 50V, X5R, 10%(K)	1
12		Cv1	CAPA CHIP C2012, 10uF, 25V, X7R, 10%(K)	1
13	TVS	T1	TVS SMD P6SMB120A, 120V, 600W	1
14	Zener-Diode	ZD1	DIOD ZENER SMD BZT52-C20, 20Vdc, 410mW	1